

Machining with ISCAR PCBN • PCD • Ceramic Inserts



Table of Contents

A Hard Advantage	3
Materials for HPT Machining	4
Range of Hard Turning Operations	5
Grinding Vs. Hard Turning	6
Materials on Hardness Scale	7
Hard Part Turning	8
ISCAR PCBN Grades	9
Choosing the Right Edge Preparation	18
PCBN Chip Breakers	23
Wiper Insert	26
PCBN for Deep Depth of Cut and Interrupted	27
Key Points for Successful HPT	29
Machine, Workpiece and Tool Holder Rigidity and Stability	30
Test Reports	31
PCBN Insert Wear	39
PCBN Designation System	40
Ceramic Inserts	41
ISCAR Ceramic Grades	43
Ceramic – Edge Preparation	49
Test Reports	50
PCD Inserts	53
Materials on Hardness Scales	55
Test Reports	57
Grade Comparison	59
Technical Information	61

A Hard Advantage

PCBN (Polycrystalline Cubic Boron Nitride) is an excellent choice of material for producing cutting tools, particularly as it can be used at extremely high cutting speeds. Second to only synthetic diamond on a scale of hardness, PCBN is characterized by its innate durability, as well as its thermal shock and chemical resistance.

ISCAR offers a wide range of PCBN and ceramic grades for HPT (Hard Part Turning). HPT refers to the turning of difficult materials such as hardened steels (45 up to 70HRC), super alloys, sintered metals and gray cast iron.

ISCAR PCBN and ceramic inserts are the first choice for HPT at high cutting speeds and are available in a wide range, including:

1. **Brazed PCBN** - Carbide as a base with brazed CBN tips or top layer for finishing operations.
2. **Solid PCBN** - for more aggressive machining conditions.
3. **Coated / Uncoated Ceramic inserts** - for different kind materials.
4. **Dimple Ceramic inserts** - for high feed machining.

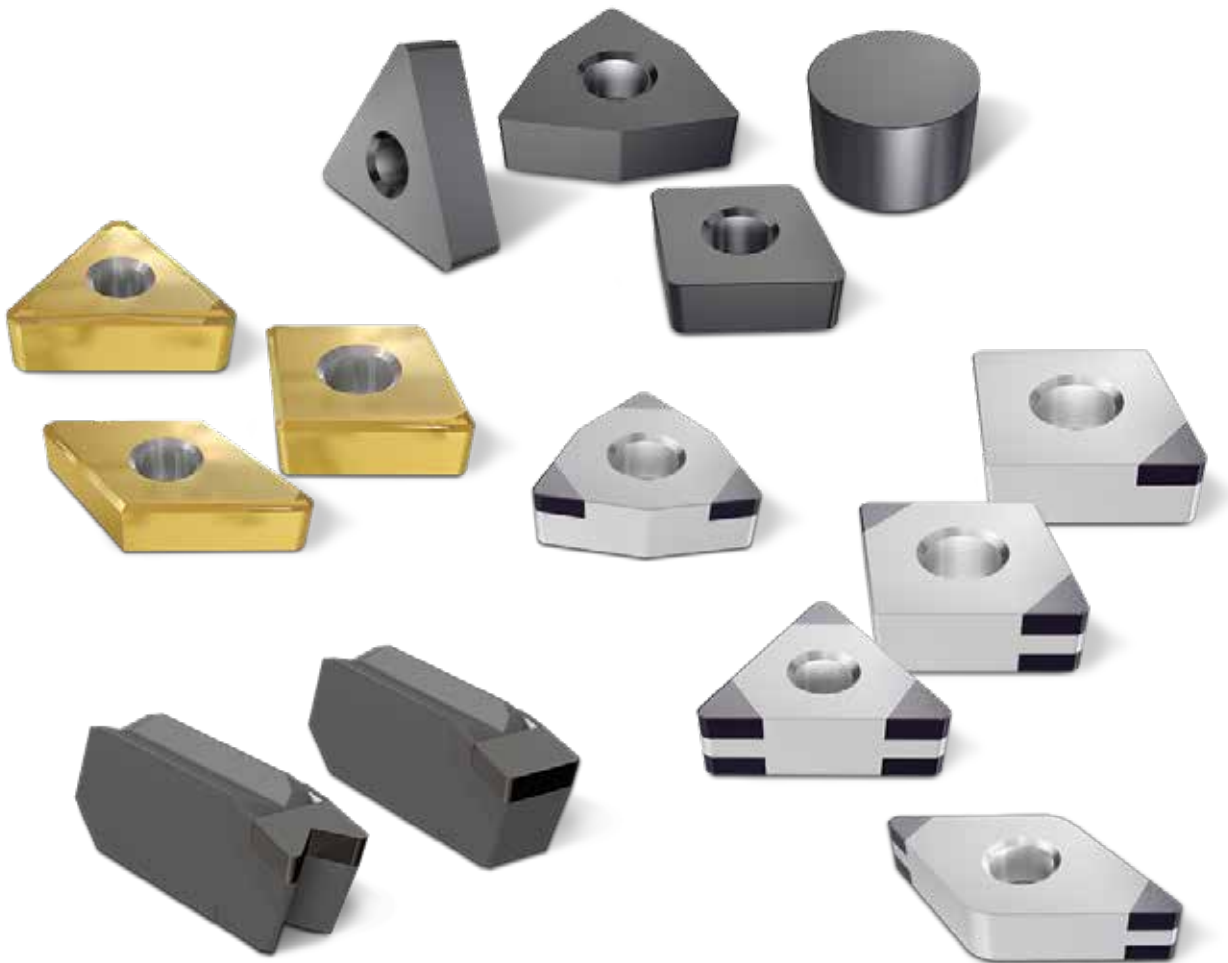

Materials for HPT Machining

There are two main types of materials for HPT (Hard Part Turning): PCBN and Ceramic inserts. In order to machine materials with high hardness level of 65 HRC, inserts with higher level of hardness than a carbide insert are necessary.

Ceramic inserts, which have a higher level of hardness than carbide, offer a good option for HPT machining from 45 to 60 HRC.

PCBN inserts are suitable for HPT machining from 50 to 70 HRC.

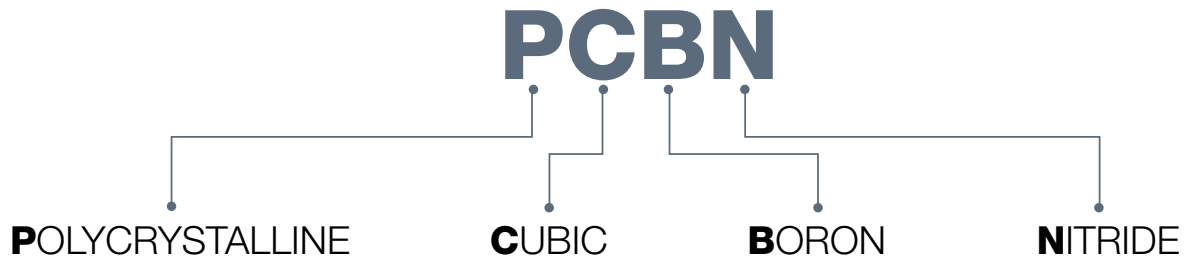

Boron Nitride is characterized by a very high hardness level - close to synthetic diamond.



Very good thermal conductor - heat removal is critical to achieve the desired outcome and long tool life.

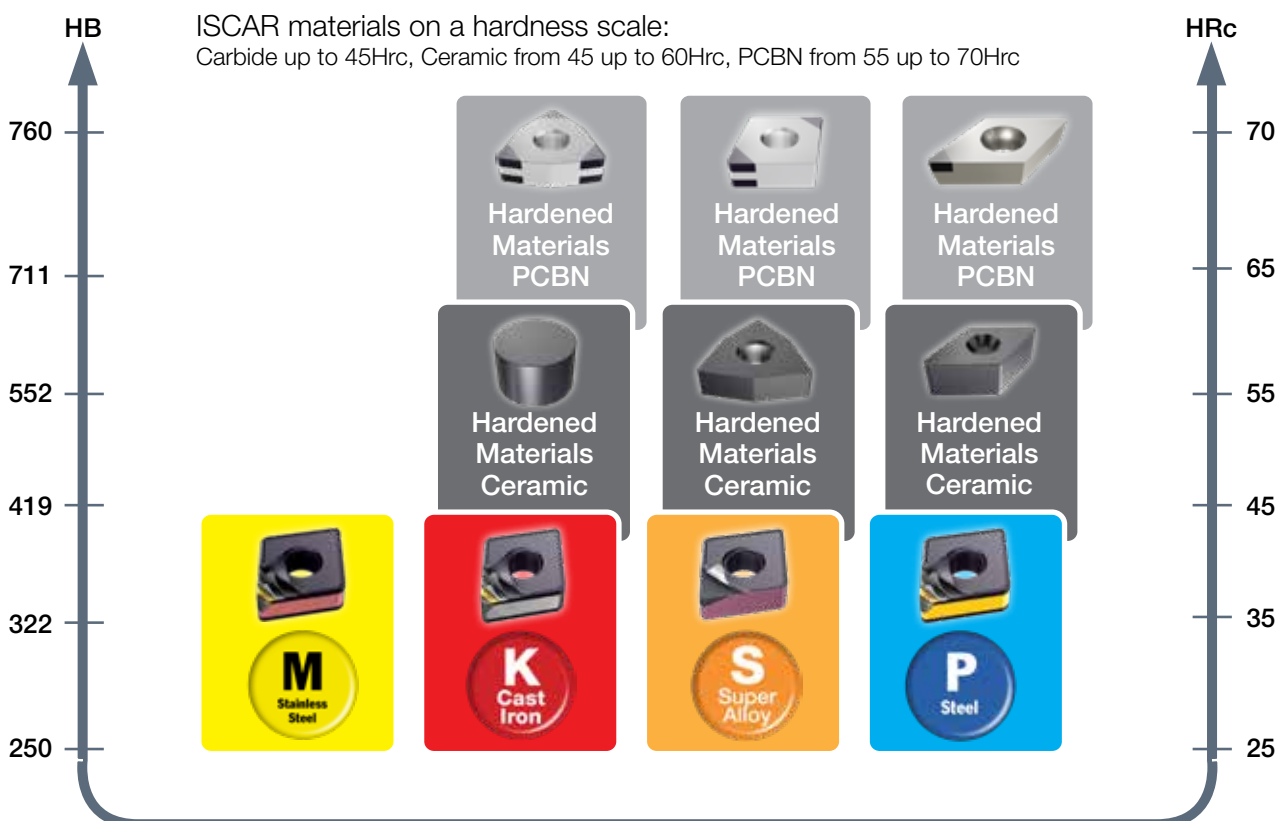

Range of Hard Turning Operations

Hard part turning (HPT) applications are similar to standard turning applications: continuous machining, light interrupted cut, and a

combination of continuous machining and light interrupted cut applications.

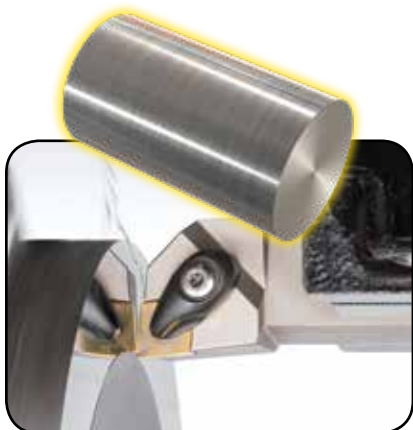

Continuous Cut



Continuous & Interrupted Cut



Interrupted Cut

ISCAR PCBN inserts are the best solution for HPT

PCBN possesses high thermal conductivity with remarkable chemical stability at high temperatures. These properties enable the machining of hardened materials at high cutting

parameters. PCBN's strong wear resistance ensures significantly extended tool life, while maintaining dimensional tolerances and superb surface finish standards.

Typical Parts – ISO-H

The demand for PCBN and ceramic grades is growing exponentially as the use of hardened materials rises throughout industry, particularly in the automotive, bearing, and die & mold industries, among others.



Shafts



Gears



Bearings



Die & Mold Parts



Pump Parts



Rolls



Hydraulic Components



HSS



Aerospace Components

Grinding Vs. Hard Turning

An important advantage in using PCBN inserts is that they can replace the slow and expensive grinding operations of hardened parts. Turning with PCBN inserts significantly reduces the cost per part when compared to grinding. ISCAR's global sales figures have shown that customers are changing their finishing processes from grinding to turning with PCBN inserts, particularly in the global automotive industries.

Grinding



- Size tolerance specifications beyond the capability of turning
- Surface finish requirements too tight for hard turning

Hard Turning



- Size tolerance specifications beyond the capability of turning
- Complex geometry that makes single-point turning more practical
- Relatively high metal removal rates
- Dry machining
- Faster machine setup
- Faster cycle times
- I.D. and O.D. machining on one machine

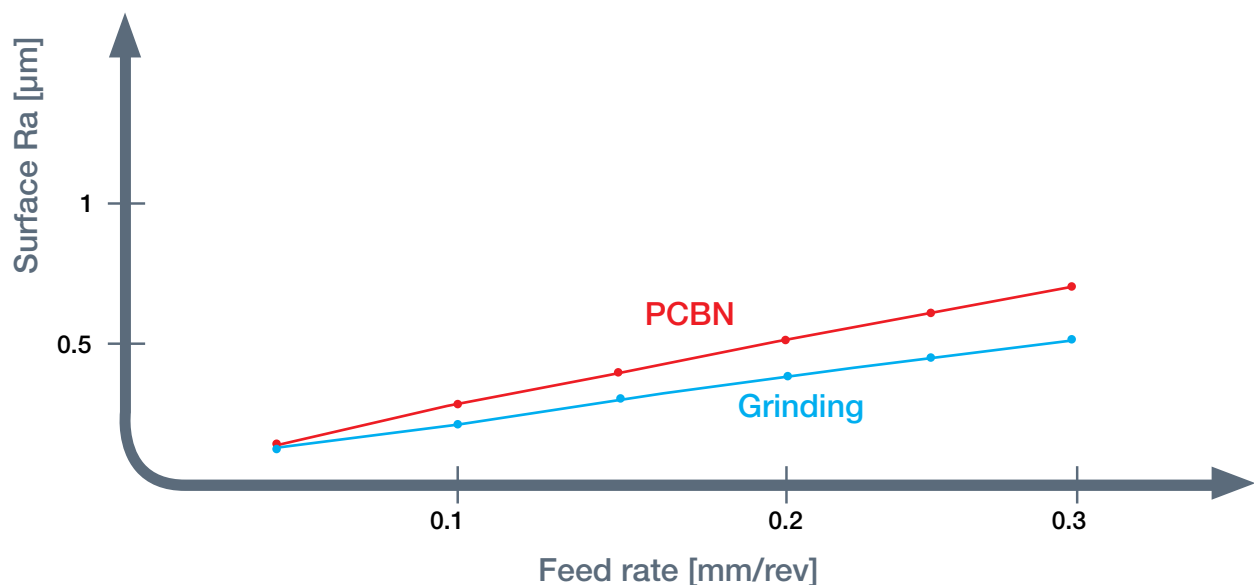

Materials on Hardness Scale

In order to machine materials with a high hardness level of 65 HRC, inserts with a higher level of hardness than carbide inserts are needed.

Vickers Hardness

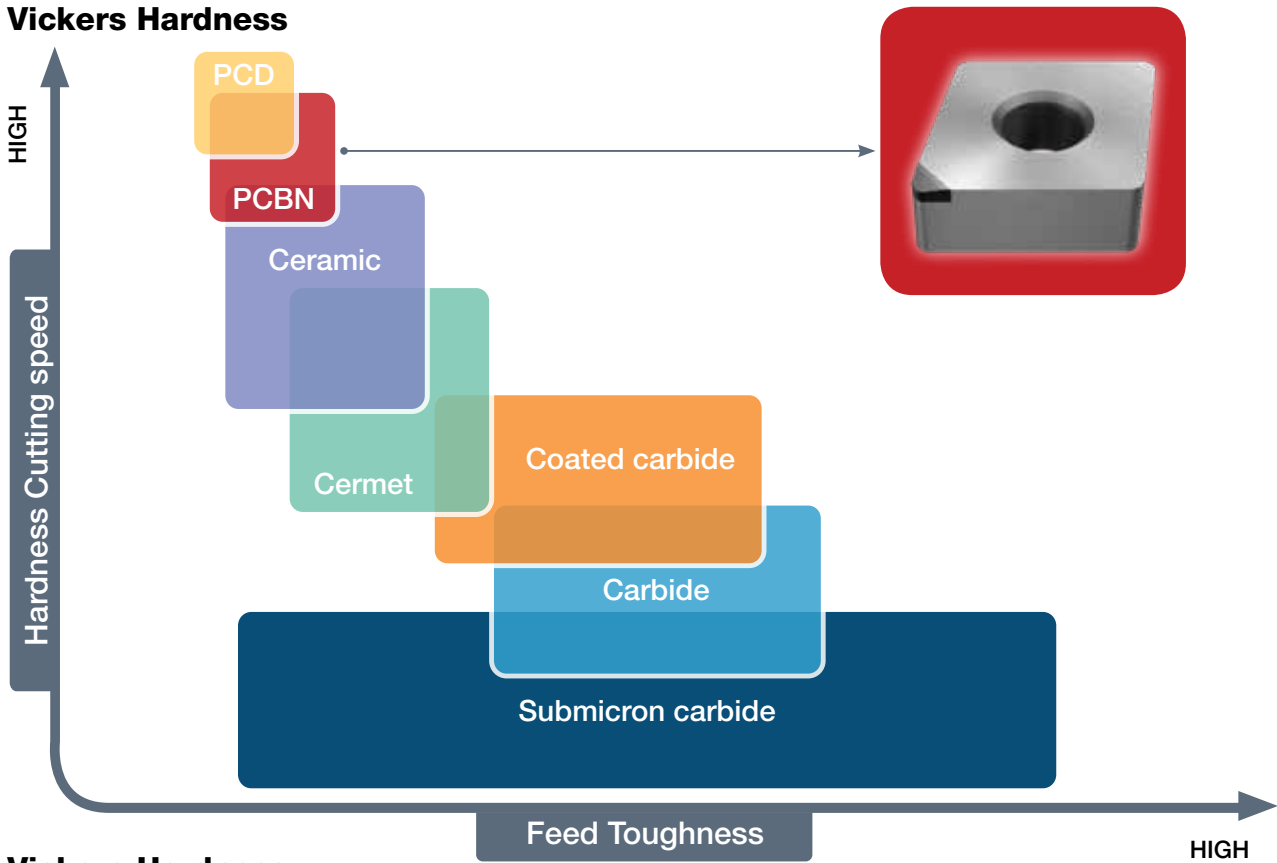

Vickers Hardness

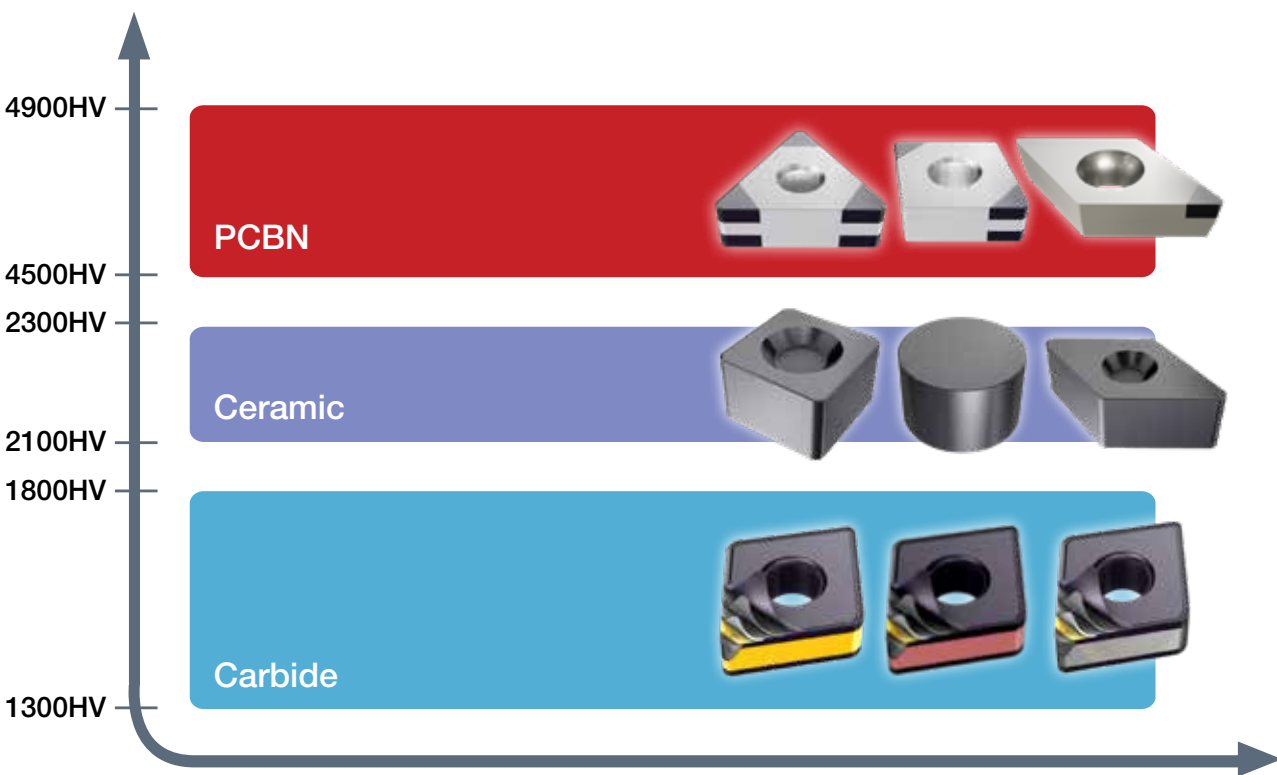



Hard Part Turning

Why carbide inserts are unsuitable for hard part turning

It is inadvisable to use carbide inserts for hard part turning (HPT) due to low chemical stability between carbide and the hard materials. The high pressure and high temperatures generated during HPT cause rapid wear and short tool life for the carbide insert.

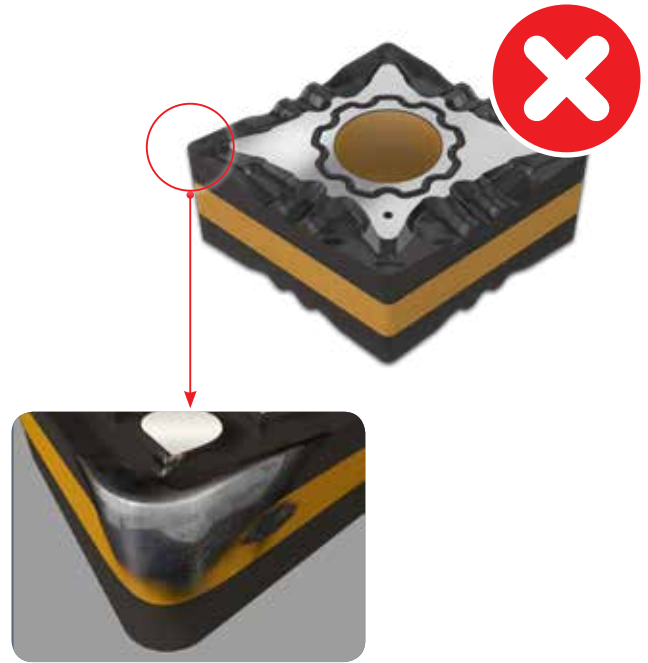

Wear Development

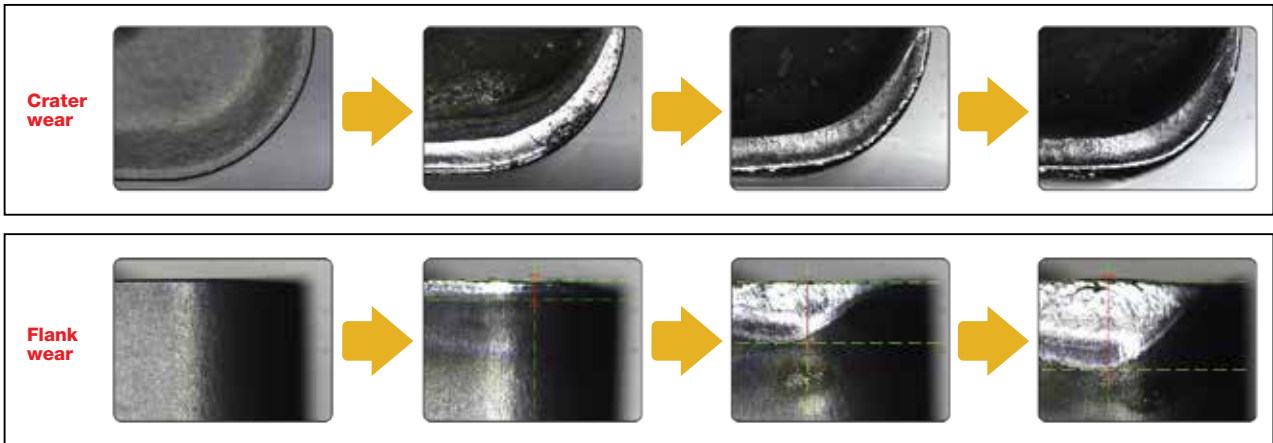

Why use PCBN on hardened materials

- Excellent wear resistance
- High toughness
- Suitable for highest surface finish demands
- Maintains close tolerances
- Can replace grinding operations, which reduces machining cost
- Semi finishing - super finishing (Depth of cut less than 0.8 mm)



ISCAR PCBN Grades



K
Cast
Iron

S
Super
Alloy

H
Hardened
Material



Choosing the Right PCBN Grade

ISCAR provides a wide range of PCBN grades. Each grade has been specifically developed for high performance in a wide spectrum of

applications, from continuous cut to heavy interrupted cutting conditions.

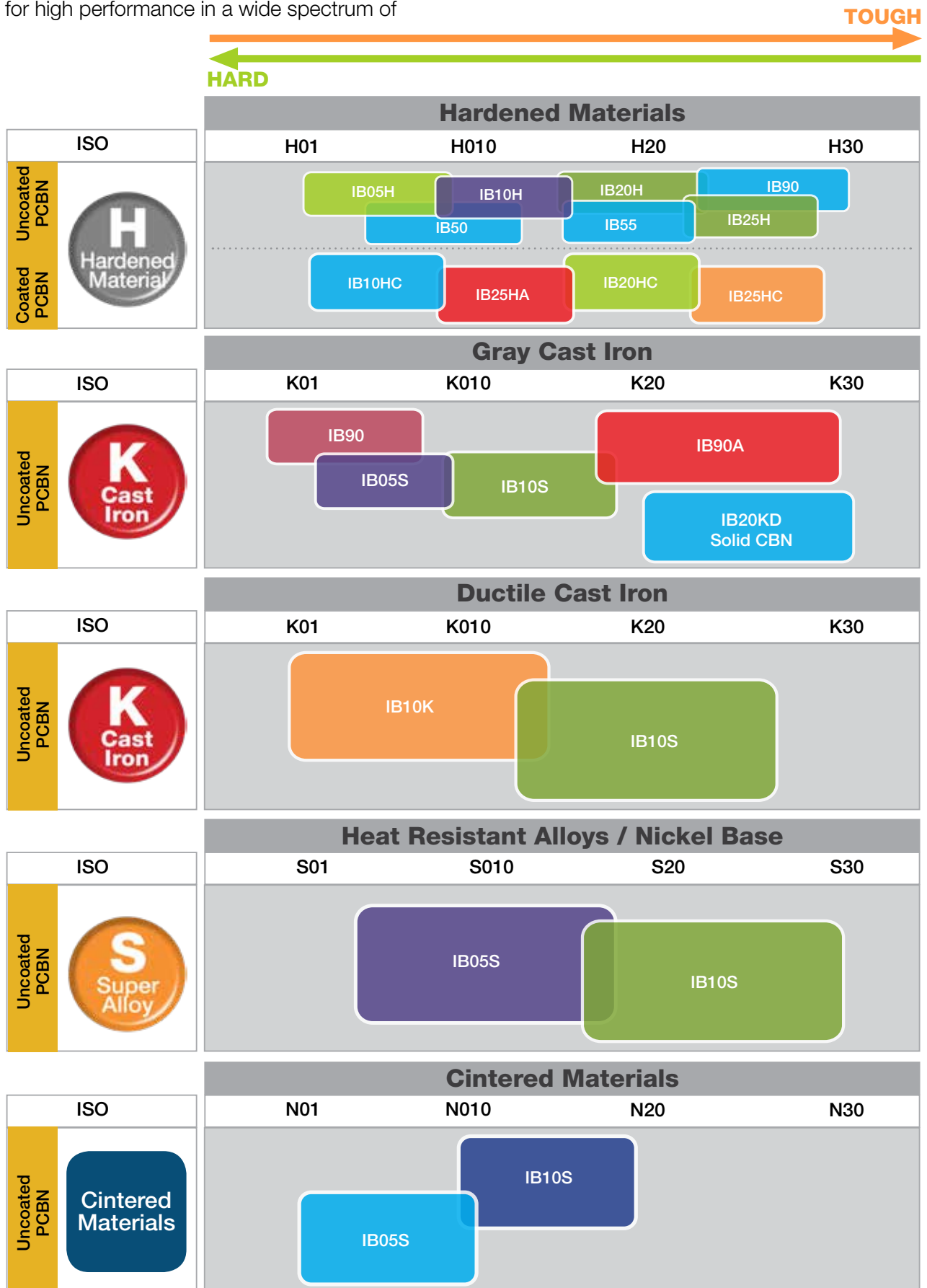

Specifications of PCBN Grades for Hardened Steel



	Grade	Coated/not Coated	Application	PCBN content %	Grade Instruction
PCBN Grades for Hardened Steel	IB05H	N		45%	High speed, continuous machining grade. The binding force between particles is improved by using relatively coarse PCBN grains. Excellent wear resistance.
	IB10H	N		53.3%	Used for finishing operations of hardened steels at medium to high cutting speeds in continuous up to light interrupted cutting conditions. Features very good wear resistance with excellent surface finish results.
	IB20H	N		65%	Used as a general purpose grade for finishing operations of hardened steels at medium cutting speeds in continuous up to medium interrupted cutting conditions. Features good balance between wear resistance and impact resistance.
	IB90	N		90%	Used for finishing operations for medium speeds on hardened steels with heavy interrupted cutting conditions. Features very high toughness and impact resistance.
	IB50	N		50%	Used for finishing operations of hardened steels at medium to high cutting speeds in continuous conditions. Features excellent wear resistance with very high surface finish results.
	IB55	N		65%	Used for finishing operations of hardened steels at medium cutting speeds in continuous up to medium interrupted cutting conditions. Features very good toughness properties at medium feeds and depths of cut.
	IB10HC	Y		53%	Coated PCBN grade for hardened steel turning. Excellent crater wear resistance for high speed machining. Newly developed PCBN substrate for high speed cutting.
	IB20HC	Y		75%	Coated PCBN grade for hardened steel turning. High chipping resistance & extremely tough substrate for all-round use.
	IB25HC	Y		75%	Coated grade for interrupted machining. Medium grained PCBN particles are bound with special binder. The surface is coated with dedicated coating material.
	IB25HA	Y		75%	Coated PCBN grade for hardened steel turning. High chipping resistance & extremely tough substrate for all-round use.

Continuous cut
 Light interrupted
 Heavy interrupted



Recommended Cutting Conditions for Uncoated PCBN Grades

Work Material	Grade	Cutting Mode	Cutting Speed M/Min			Feed mm/rev	Depth of cut mm
			Continuous Cut	Light interrupted	Heavy interrupted		
 50-65HRC	IB05H	High speed continuous hard turning	100-300	-	-	0.03-0.18	0.05-0.30
	IB10H	Continuous to light interrupted grade for superior surface finish	80-200	80-150	-	0.03-0.18	0.05-0.30
	IB20H	Continuous to ordinarily interrupted turning	80-200	80-200	-	0.03-0.25	0.05-0.50
	IB25H	Tough grade for heavily interrupted turning	-	-	80-200	0.03-0.25	0.05-0.50
	IB90	Toughest grade for heavily interrupted turning	-	-	80-120	0.03-0.30	0.05-0.50
	IB55H	Finishing operations at continuous to light interrupted cutting	80-200	80-200	-	0.03-0.25	0.05-0.50
	IB50	Very fine PCBN grain High speed continuous machining	80-200	80-200	-	0.03-0.18	0.05-0.3

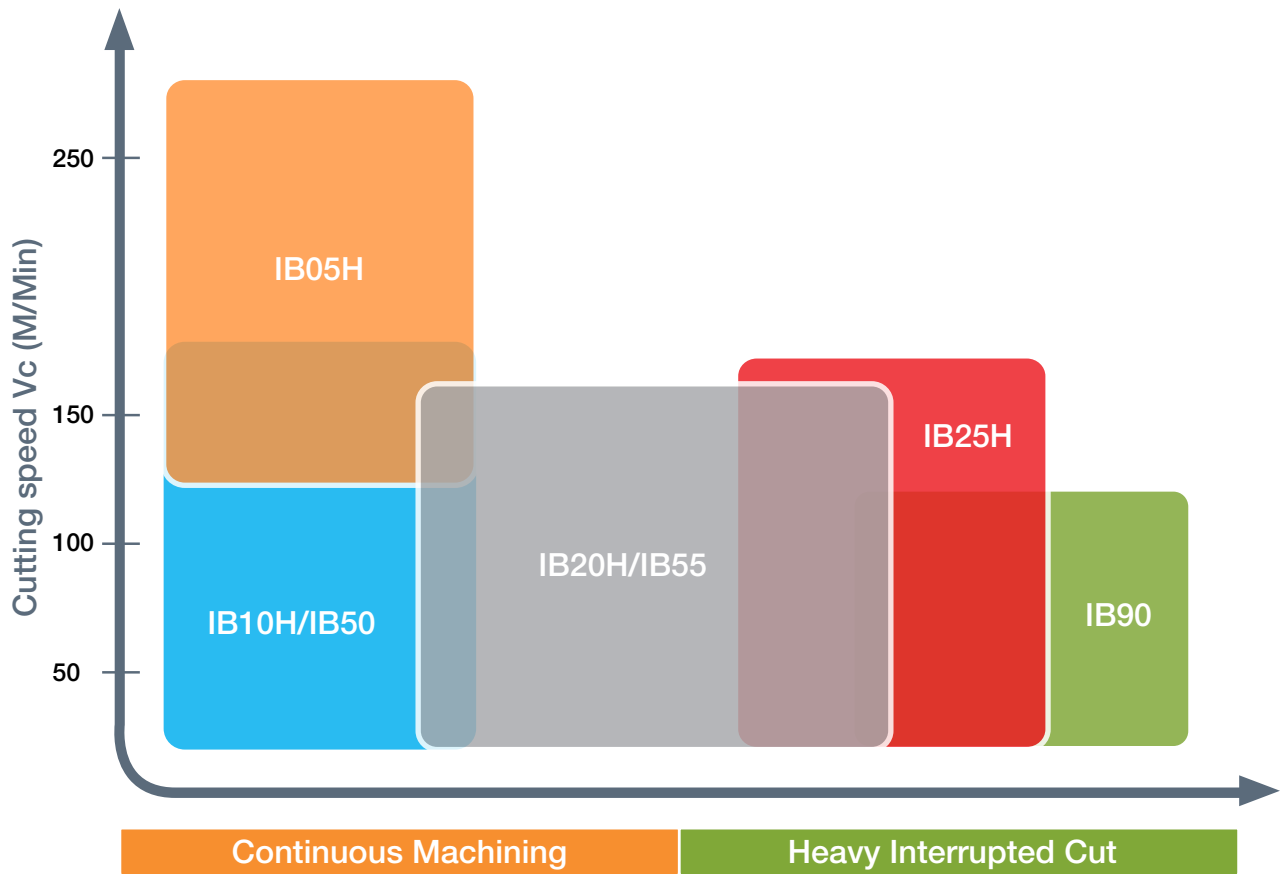





Recommended Cutting Conditions for Hardened Steel with Coated PCBN Grades 50-65HRC

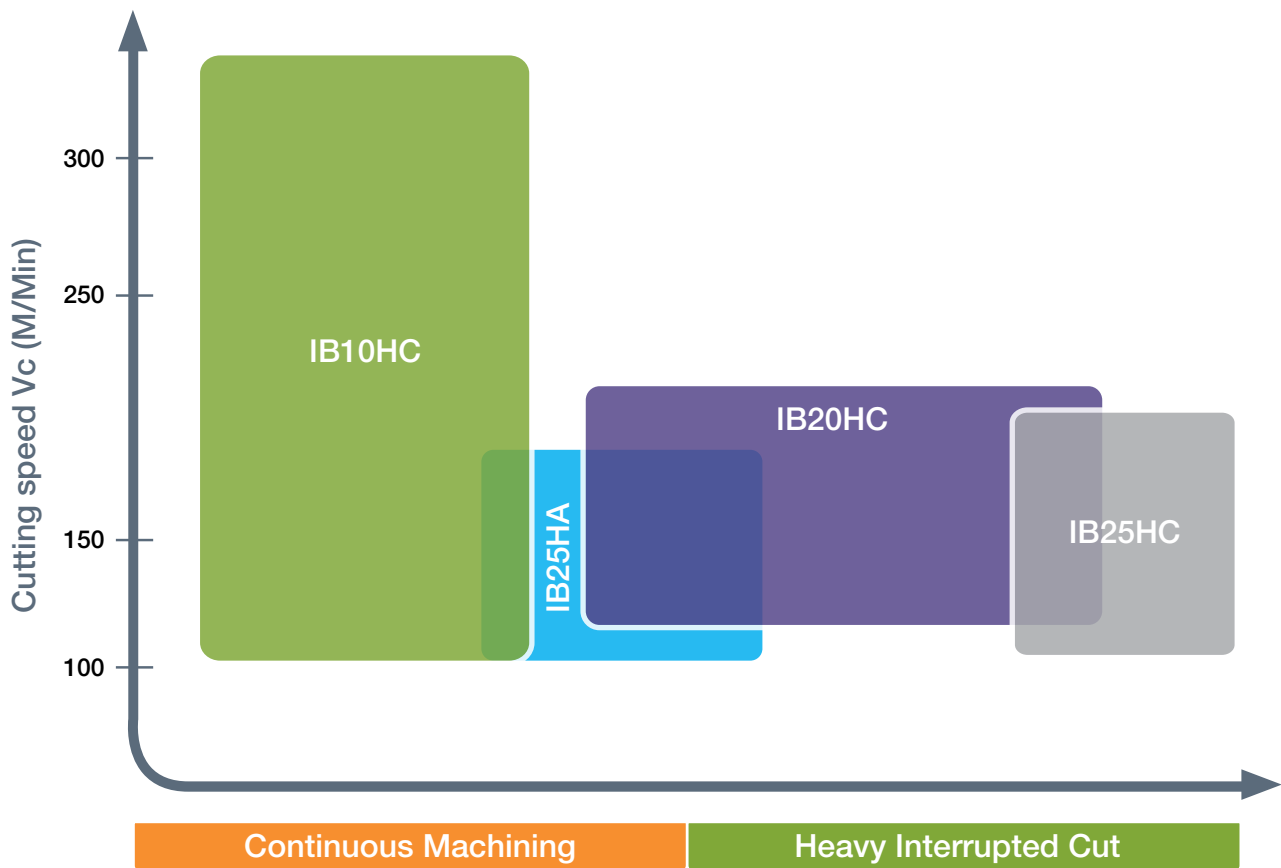

Work Material	Grade	Cutting Mode	Cutting Speed M/Min			Feed mm/rev	Depth of cut mm
			Continuous Cut	Light interrupted	Heavy interrupted		
	IB10HC	Coated grade for high speed continuous turning	150-350	100-300	-	0.05-0.20	0.05-0.30
	IB20HC	Coated grade for high speed interrupted turning	-	150-250	150-200	0.05-0.25	0.05-0.50
	IB25HA	Coated grade for middle interrupted turning	-	100-220	-	0.05-0.25	0.05-0.50
	IB25HC	Coated grade for interrupted turning	-	-	100-220	0.05-0.25	0.10-0.50



Specifications of PCBN Grades for Cast Iron

	Grade	Coated/Not Coated	Application	PCBN content %	Grade Instruction
PCBN Grades for Gray Cast Iron	IB90	N		90%	Used for finishing operations of cast iron at high cutting speeds, and also for medium speeds on hardened steels with heavy interrupted cutting conditions. Features very high toughness and impact resistance.
	IB05S	N		95%	Uncoated grade that contains 95% PCBN composed of super fine grain size in a special binder. Used for finishing operations with continuous conditions on sintered metals at high cutting speeds. Features high hardness and ensures very good surface finish.
	IB10S	N		65%	Uncoated grade that contains 95% PCBN composed of fine grain size in a special binder. Used for finishing operations on sintered metals at high cutting speeds and also for valve seats and Titanium alloys at continuous up to light interrupted cutting conditions. Features high hardness and good wear resistance.
	IB90A	N		90%	Solid uncoated grade that contains 90% PCBN composed of coarse grain size in a special binder. Used for medium to roughing operations of cast iron at high speeds. Excellent for heavy interrupted cutting conditions, and also suitable for hardened steel machining with interrupted conditions. Features toughness and excellent impact resistance.
	IB25KD	Y		90%	Coated solid grade for high speed continuous or interrupted machining. Medium grained PCBN particles are bound with special binder. The surface is coated with dedicated coating material.

 Continuous cut
  Light interrupted
  Heavy interrupted





Recommended Cutting Conditions for PCBN Grades

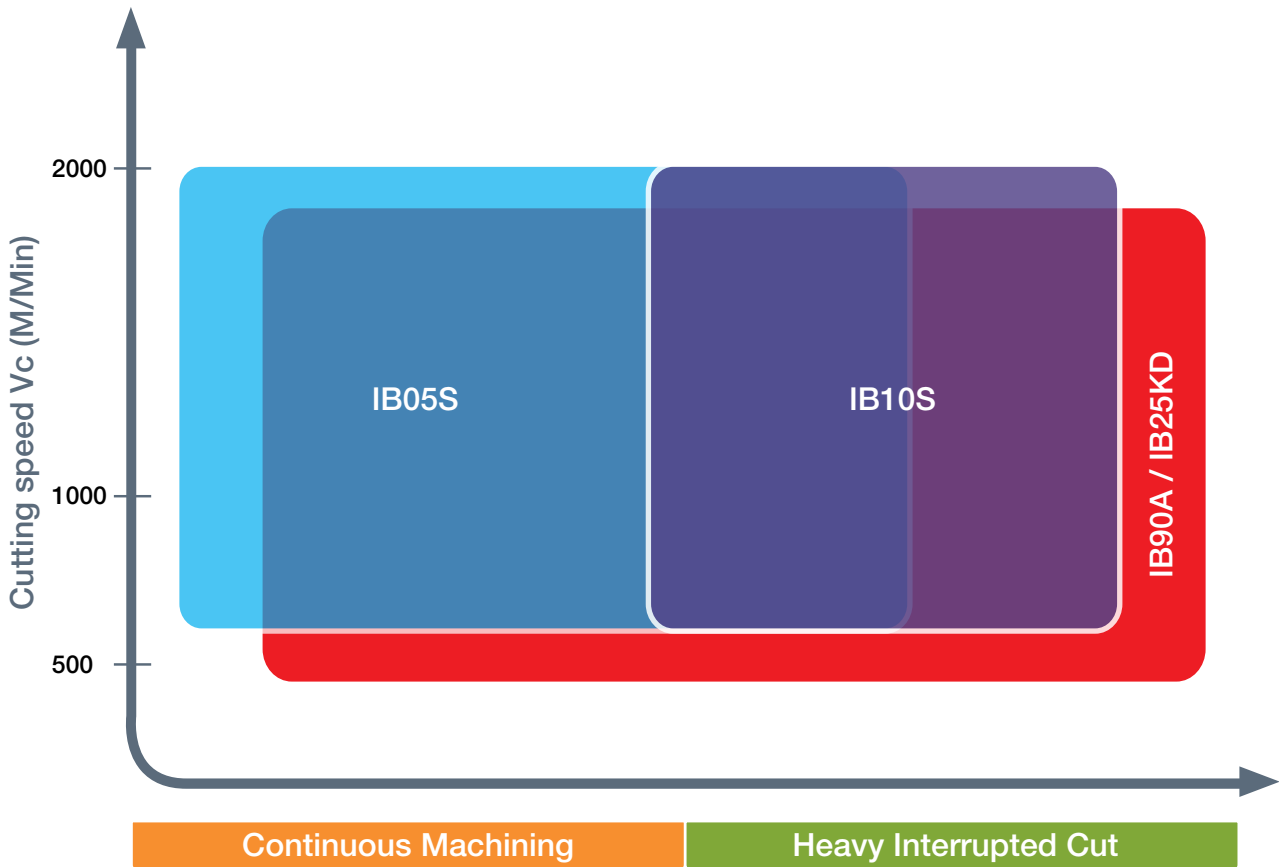

Work Material	Grade	Cutting Mode	Cutting Speed M/Min			Feed mm/rev	Depth of cut mm
			Continuous Cut	Light interrupted	Heavy interrupted		
	IB05S	Continuous to light interrupted finishing	500-2000	500-2000	-	0.05-0.30	0.05-0.50
	IB10S	Interrupted finishing	-	500-2000	500-1000	0.05-0.30	0.05-0.50
	IB90A	Solid PCBN grade for large DOC turning	500-2000	500-2000	500-1000	0.05-0.40	0.10-4.00
	IB25KD	Coated solid PCBN grade for large DOC turning	500-1400	500-1900	500-1700	0.05-0.40	0.10-4.00



Specifications of PCBN Grades for Super Alloys

	Grade	Coated/Not Coated	Application	PCBN content %	Grade Instruction
PCBN Grades for Super Alloys	IB05S	N		95%	Super fine grain PCBN grade for machining ferrous sintered metals. The highest content of PCBN in the world as a practical tool material.
	IB90	N	 	90%	Suitable for super alloys. High fracture resistance. Good performance in high-speed machining.

 Continuous cut

 Light interrupted



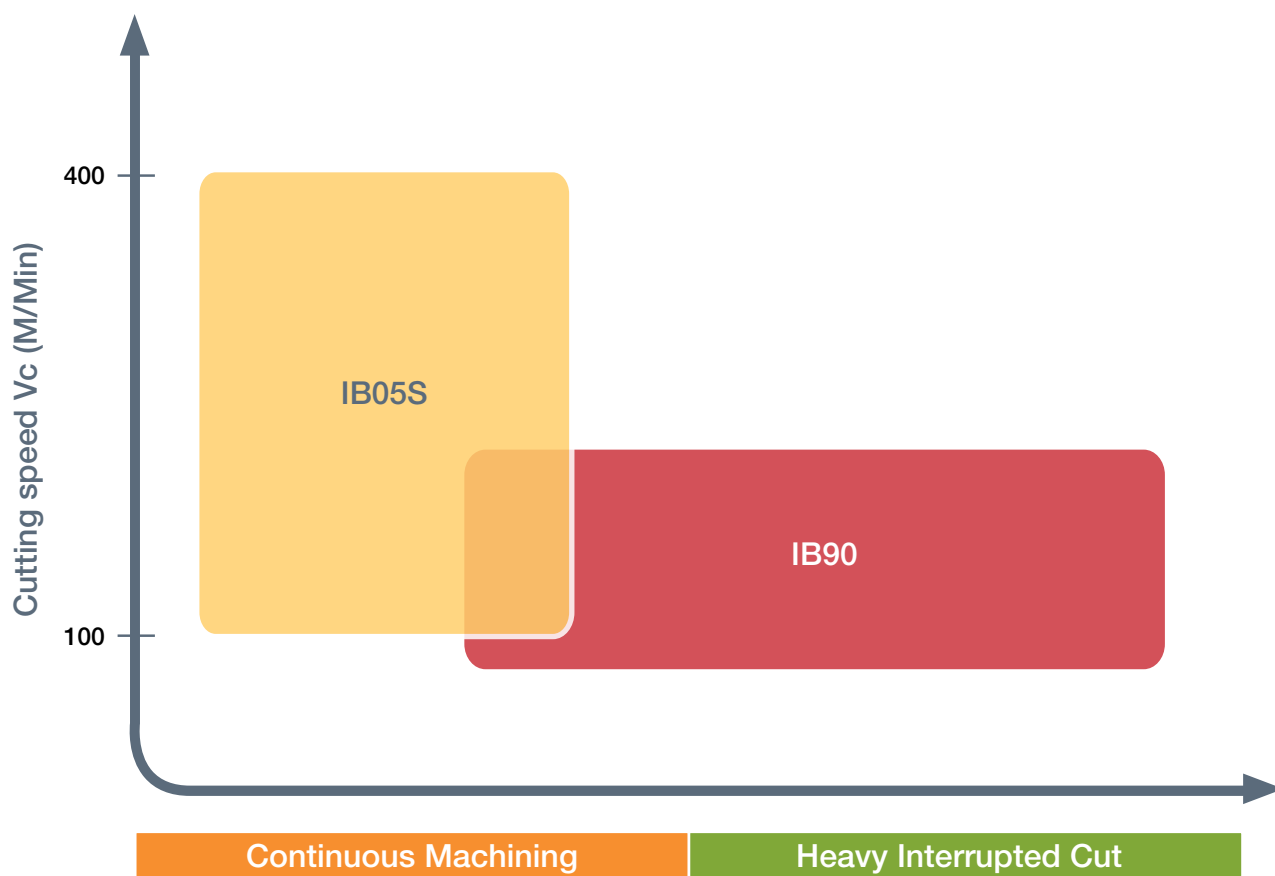

 Heavy interrupted

Recommended Cutting Conditions for PCBN Grades

Work Material	Grade	Cutting Mode	Cutting Speed M/Min			Feed mm/rev	Depth of cut mm
			Continuous Cut	Light interrupted	Heavy interrupted		
	IB90	For interrupted machining	100-300	80-300	80-200	0.05-0.20	0.10-0.50
	IB05S	For high speed continuous machining	100-400	-	-	0.05-0.20	0.10-0.50



Specifications of PCBN Grades for Sintered Metals

	Grade	Coated/Not Coated	Application	PCBN content %	Grade Instruction
PCBN Grades for Sintered Metals	IB05S	N	 	95%	Super fine grain PCBN grade for machining ferrous sintered metals. The highest content of PCBN in the world as a practical tool material.
	IB10S	N	 	95%	Uncoated grade that contains 95% PCBN composed of fine grain size in a special binder. Used for finishing operations on sintered metals at high cutting speeds and also for valve seats and Titanium alloys at continuous up to light interrupted cutting conditions. Features high hardness and good wear resistance.

 Continuous cut
  Light interrupted
  Heavy interrupted

Recommended Cutting Conditions for PCBN Grades

Work material	Grade	Cutting Mode	Cutting speed M/Min			Feed mm/rev	Depth of cut mm
			Continuous Cut	Light interrupted	Heavy interrupted		
	IB10S	Tougher grade for interrupted turning	-	100-400	100-400	0.05-0.30	0.05-0.50
	IB05S	High wear resistance grade	100-400	100-400	-	0.05-0.30	0.05-0.50

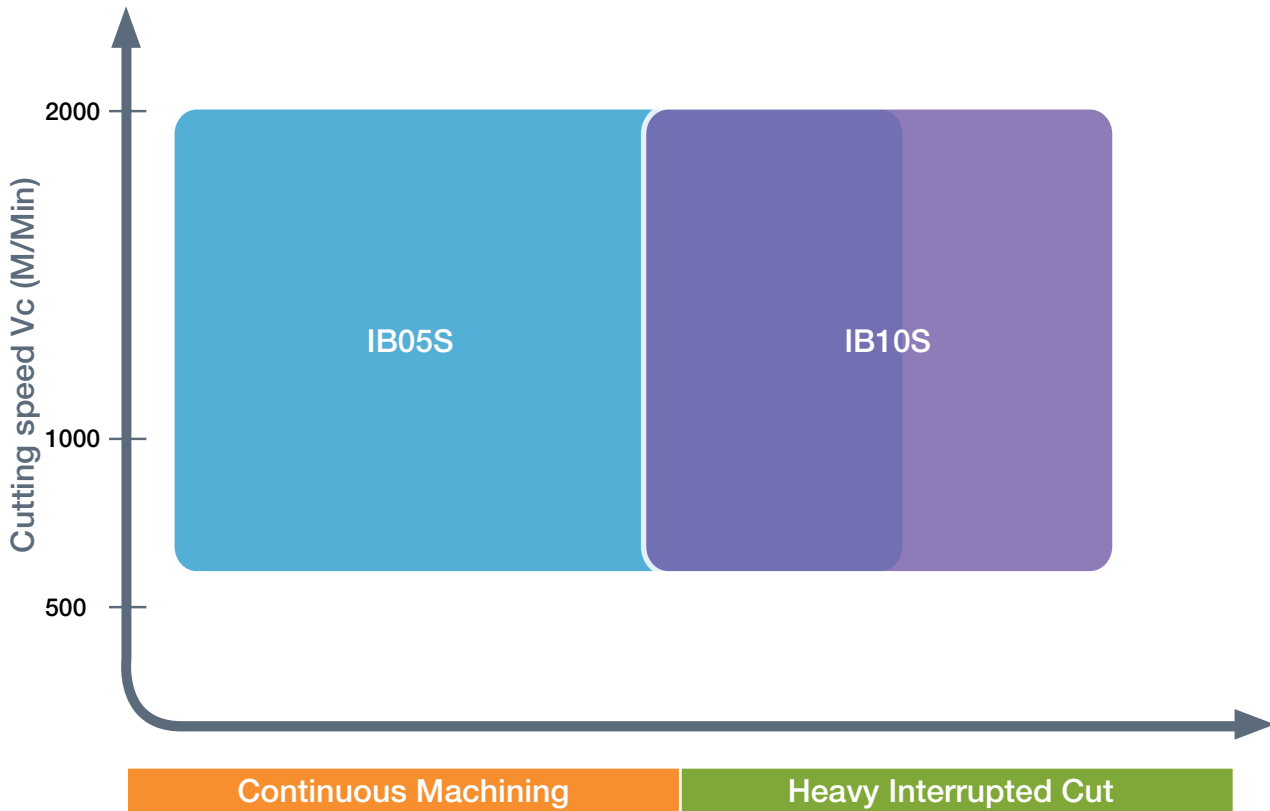

Choosing the Right Edge Preparation

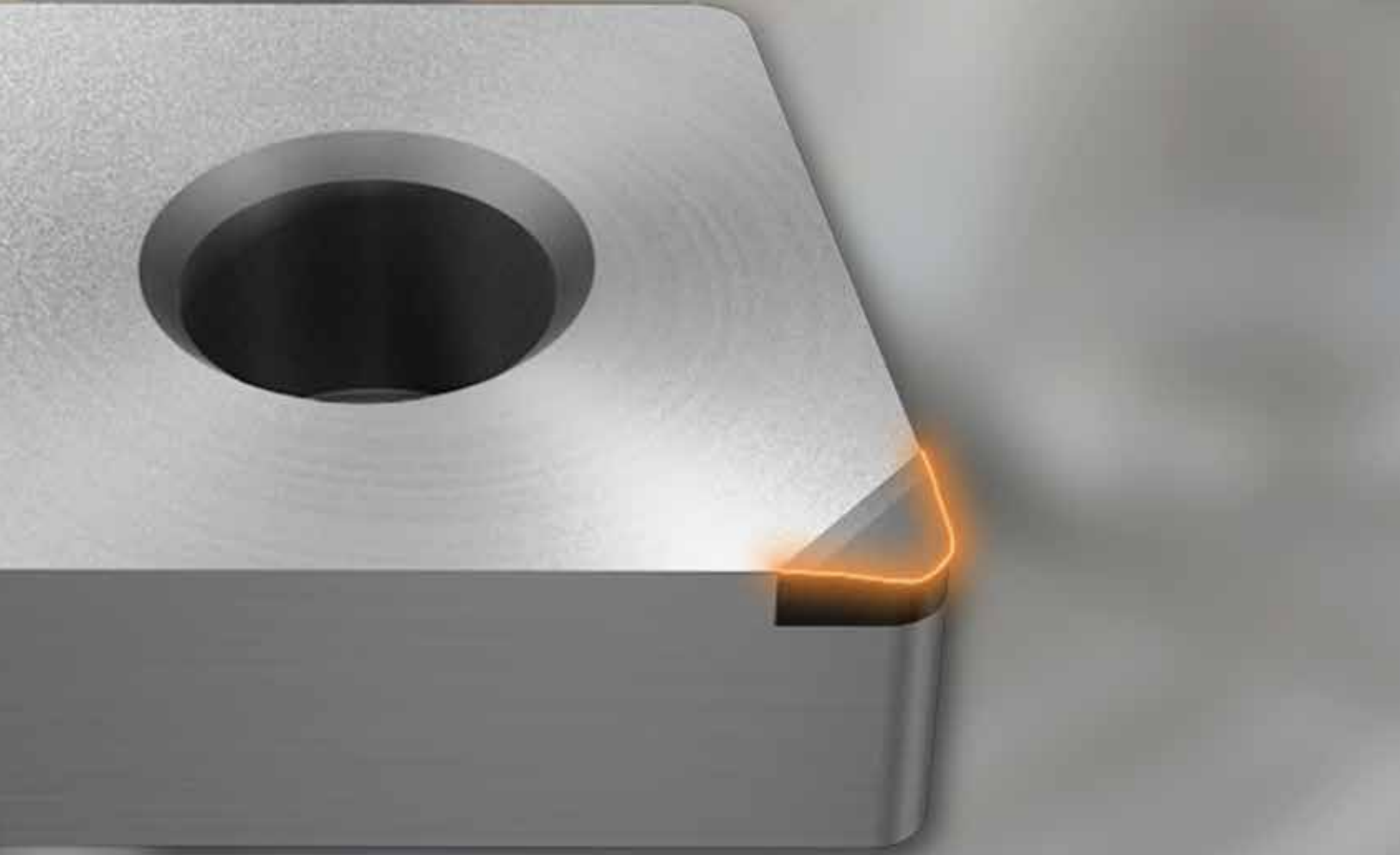

Choosing the Right Edge Preparation

Correct PCBN insert edge preparation is essential in hard part turning.

Appropriate edge choice can lengthen tool life dramatically, reduce costs and increase productivity by saving machining time.

GRIP Insert Edge Preparation

Choosing the Right Edge Preparation

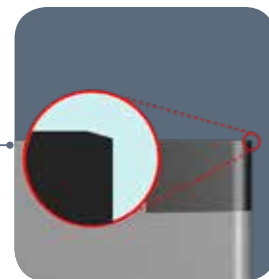

For Continuous
0.2mmX20°

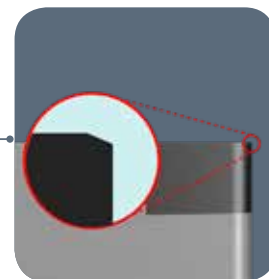

For Interrupted
0.15mmX30°

PCBN Edge Preparation

Choosing the Right Edge Preparation

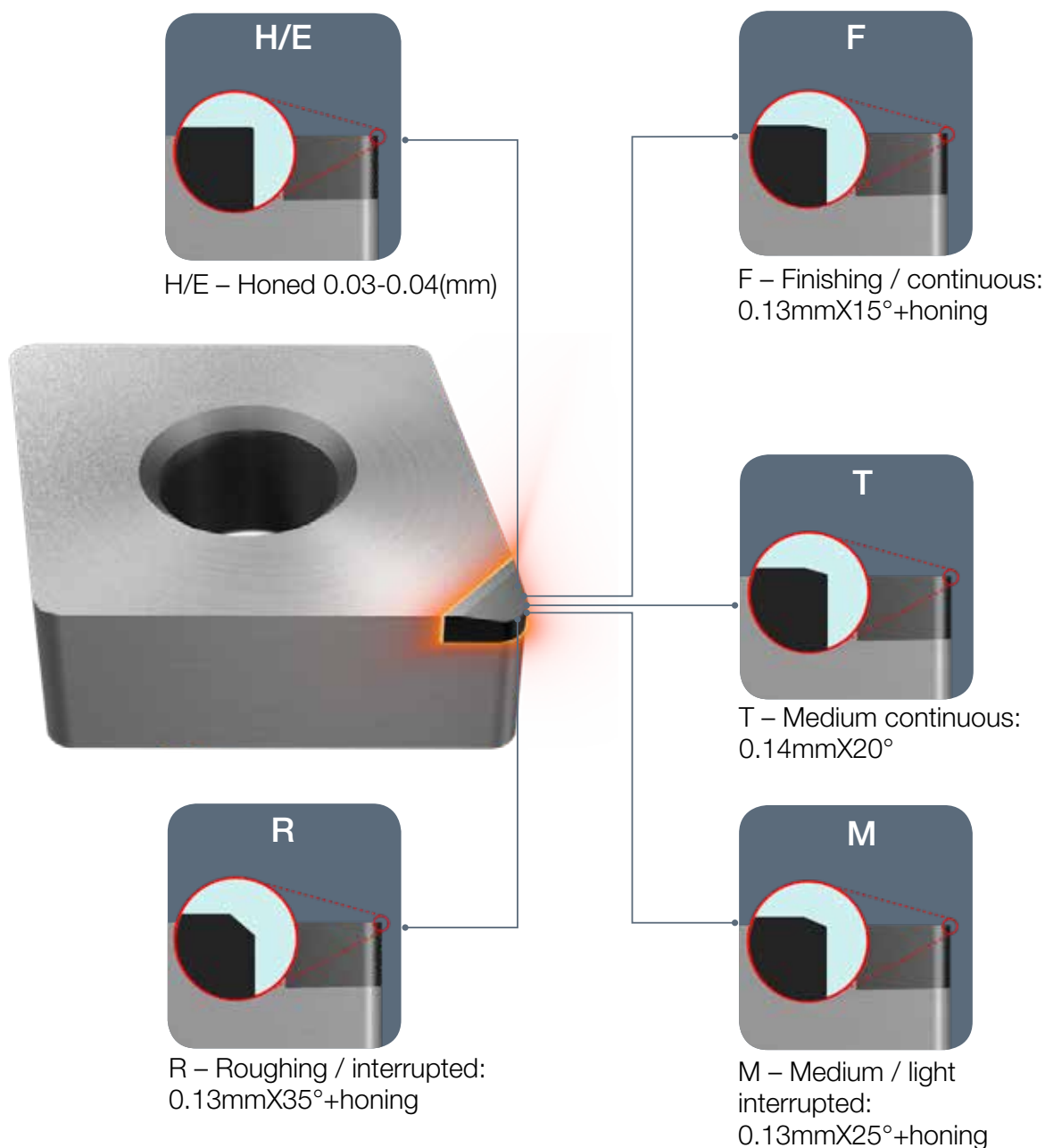

PCBN Edge Preparations:

Sharp edges are generally not recommended on PCBN since the sharp edge can chip or break quickly. A sharp edge can be used when cutting forces need to be reduced due to unstable workpiece clamping or machine limitations.

H/E - Honed Edge (honing only)
Honing helps strengthen and protecting the edge from chipping and fracturing. Honing can bring benefits (superior surface) in special finishing applications.

R - Land for roughing/interrupted applications (0.13mmX35°+honing).

M - Land for medium/light interrupted applications (0.13mmX25°+honing).

F - Land for finish / continuous applications (0.13mmX15°+honing).

T - Land (chamfer without honing)
T-land is a common edge preparation on PCBN/Ceramics (0.14mmX20°).

PCBN Edge Preparation

Choosing the Right Edge Preparation

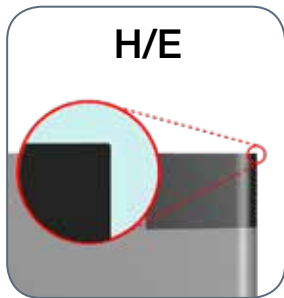

H/E
Honed
0.03-0.04(mm)

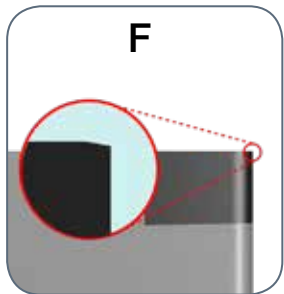
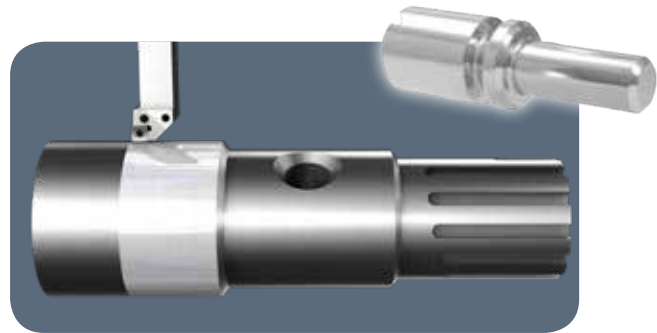

F
Finishing / continuous:
0.13mmX15°+honing

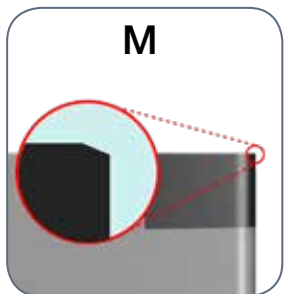
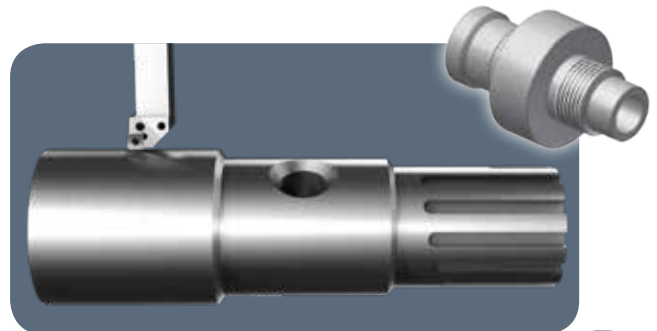

M
Medium / light
interrupted:
0.13mmX25°+honing

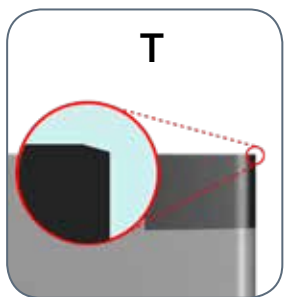
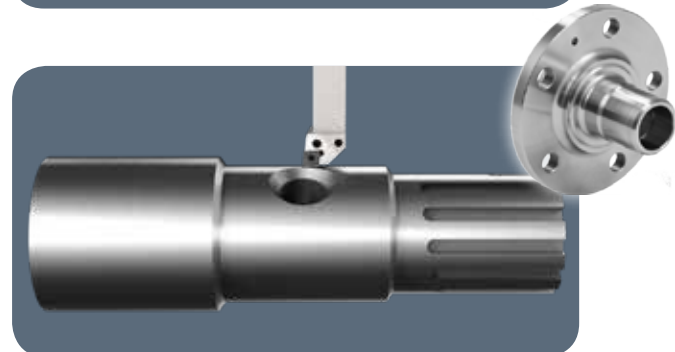



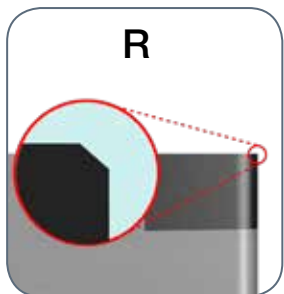
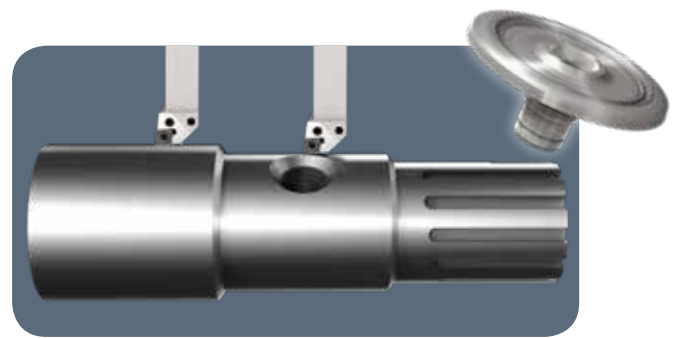



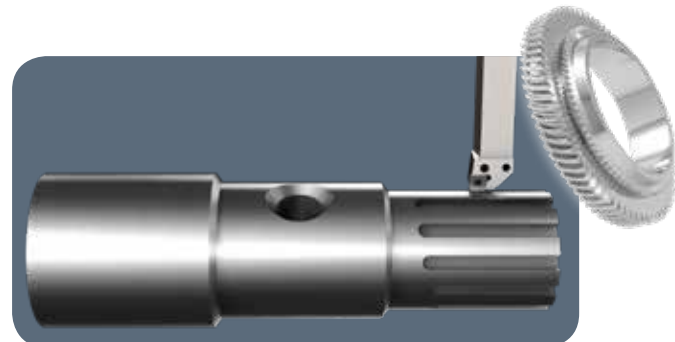

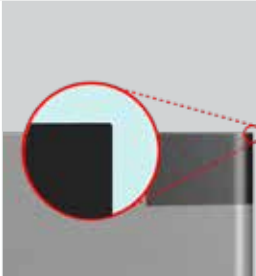

T
Medium continuous:
0.14mmX20°

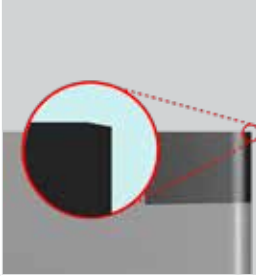

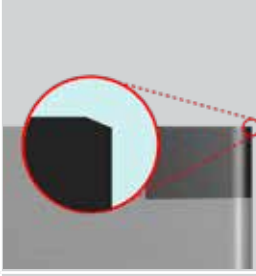
R
Roughing/ interrupted:
0.13mmX35°+honing

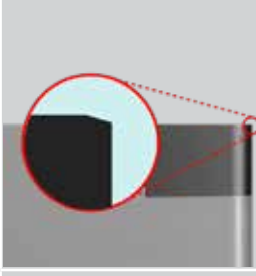

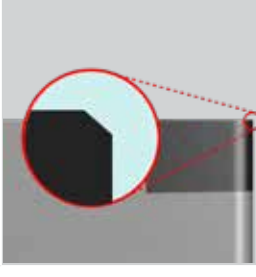
ISCAR PCBN Edge Preparation

PCBN edge preparation for hardened steel	PCBN Edge Description	Edge Prep Type	Edge Prep Honing/ T-Land	Application	Edge Instruction
	H/E		0.03-0.04(mm)		Honing helps strengthen the edge, protecting the edge line from chipping and fracturing. Carefully applied, it can bring benefits when special surface finish or special tolerances is required.
	F		0.13mmX15°		Small chamfer that strengthens the cutting edge. Recommended for continuous cut or when lower cutting forces are required. Feed rates must be greater than the hone size to allow actual cutting action and prevent rubbing.
	M		0.13mmX25°	 	Medium chamfer that strengthens the cutting edge. First choice for PCBN inserts. Recommended for continuous cut up to light interrupted cut. Feed rates must be greater than the hone size to allow actual cutting action and prevent rubbing.
	T		0.14mmX20°	 	Chamfer without honing. Recommended for continuous and light interrupted cut.
	R		0.13mmX35°	 	Big chamfer that gives very strong cutting edge. Recommended for interrupted cut and unstable machine conditions. Feed rates must be greater than the hone size to allow actual cutting action and prevent rubbing.

 Continuous cut

 Light interrupted

 Medium

 Heavy interrupted

PCBN Chip Breakers

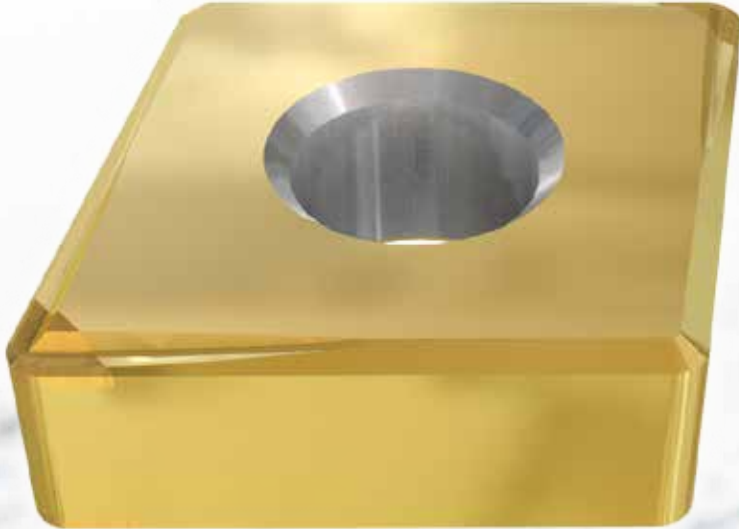

PCBN – Chip Breakers

ISCAR presents a new generation of PCBN inserts with the inclusion of efficient chipbreakers that provide improved chip control. When using the standard PCBN flat top inserts (without chipformers), long unbroken and uncontrolled chips are often produced. These chips may harm the workpiece surface and interrupt the machining process.

The new ISCAR PCBN inserts, with HF & HM chipbreakers, provide excellent chip control at various depths of cut. ISCAR's PCBN inserts with chip breakers solve the problem of long and curled chips.



IB25HA + Chip Breaker



HM – for medium and rough cutting

Relatively wide chip breaker allows cutting control at large depth of cut



HF – for high surface finish

The flat surface on the corner allows excellent chip control at small depth of cut



New chip breakers for hardened materials when turning hard materials: long and tangled chips are produced.



Chip Breaking Area

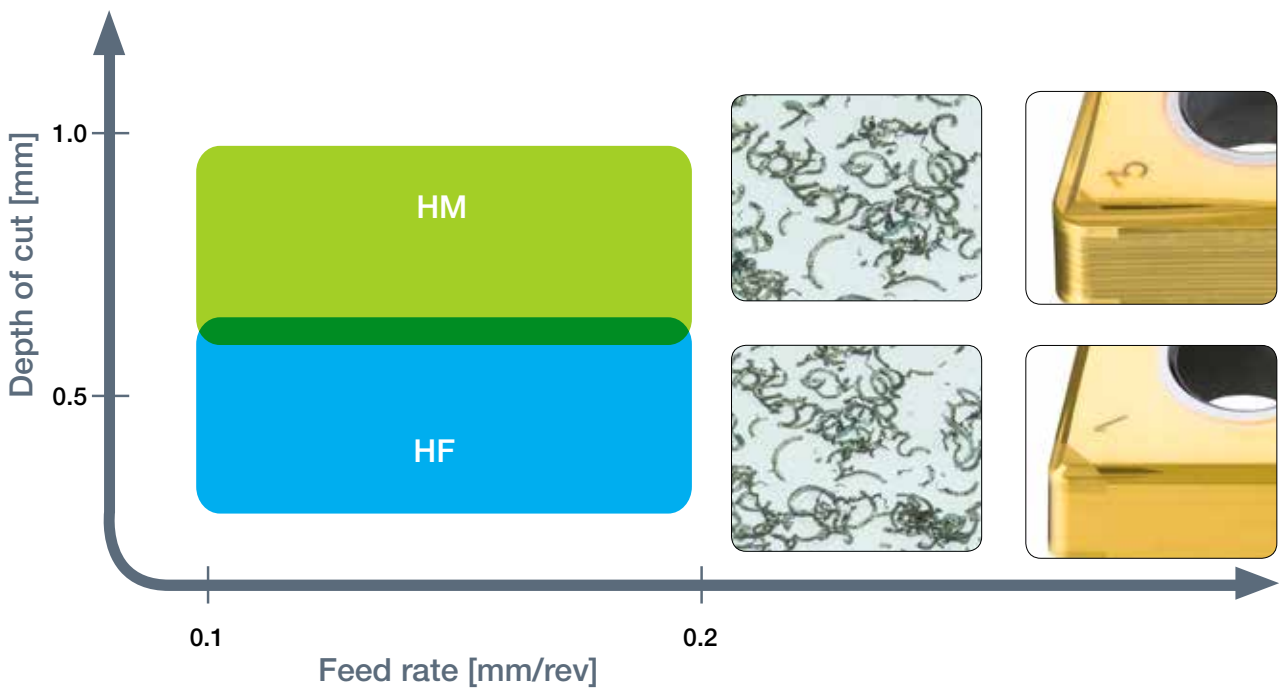

Wiper Insert

PCBN inserts are mainly for finishing and super finishing on hard part turning. All PCBN inserts are grounded all around for maximum accuracy, better repetition and increased surface quality - an important element of PCBN in the wiper configuration which helps greatly to improve surface finish/quality (similar to grinding). The wiper enables work with a higher feed rate and good surface finish on the work piece.

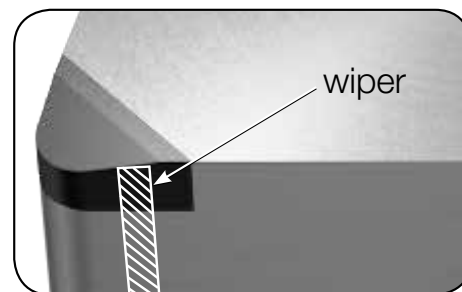

CBN insert with wiper advantages:

- Wiper turning inserts for faster feeds with better finishes
- Can be used on roughing and finishing operations
- Increased tool life
- Fits on all standard turning tool holders as every one of the standard turning inserts
- Strong cutting edge produces superior surface finishes, even at heavier semi-finishing depths of cut
- Improved chip control - under high feed conditions, the chips generated become thicker and are more easily broken, which improves chip control

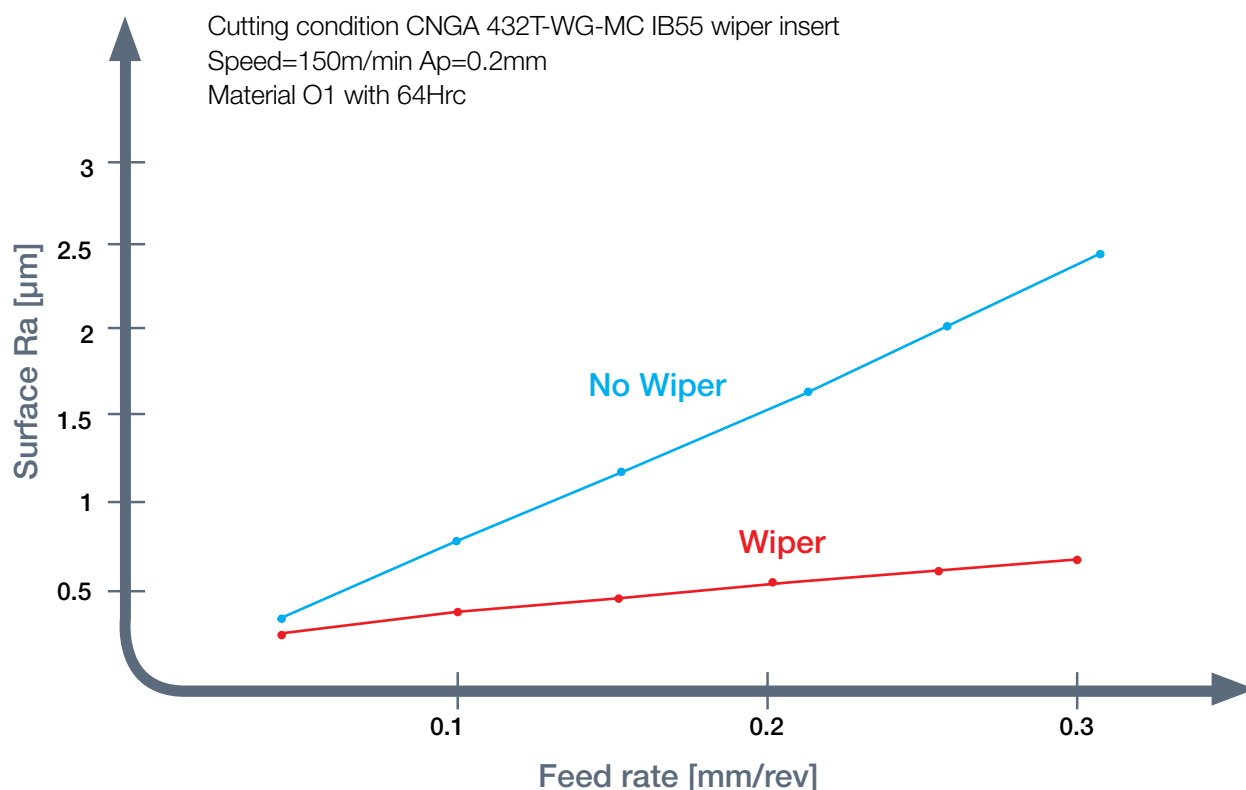

PCBN for Deep Depth of Cut and Interrupted



PCBN for Deep Depth of Cut and Interrupted

Innovative technology securing machining stability, lower cutting temperatures and leading to reduced crater wear development.

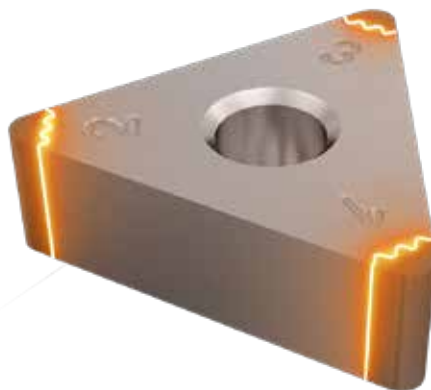
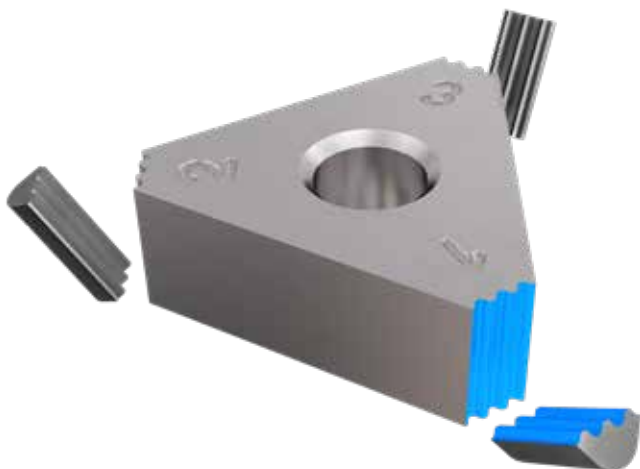

The large brazing surface empowering thermal thermal conductivity and reduce the temperature at the cutting edge.

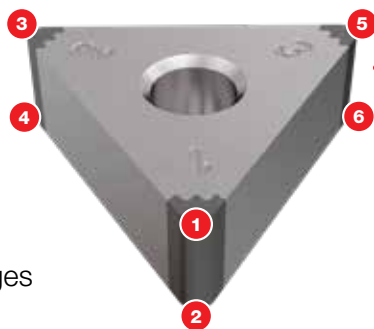

All cutting edges can be used



Click Link to ▶ <https://youtu.be/F1osu2nowbc>
See Short Video ▶ <https://youtu.be/tqG40jF-97o>



Application range

Continuous cut

Light interrupted

Heavy interrupted

Key Points for Successful HPT

Soft state preparation (before hardening):

Machine close to the final dimensions, leaving only a few tenths for the finishing operation. Make chamfers and radiuses (sharp corners can damage or break the corner - PCBN and ceramic grades don't work well with sharp corners).



Make chamfers and radiuses

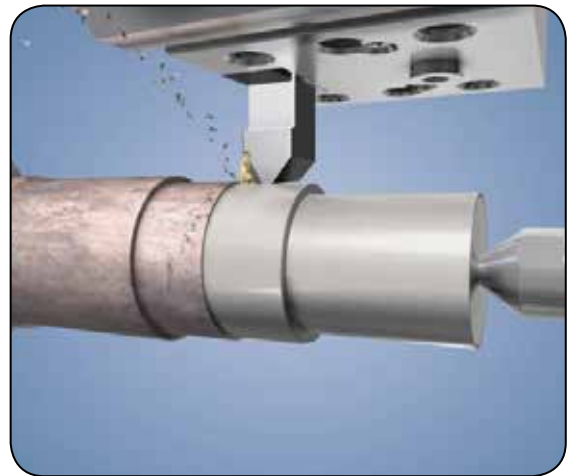

Close to final dimensions & smooth contour

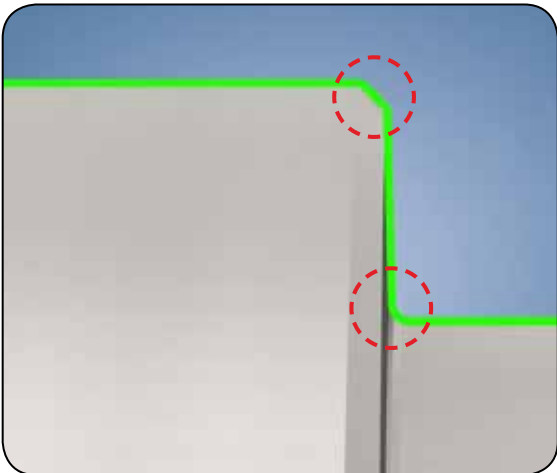

Chamfers and radiuses

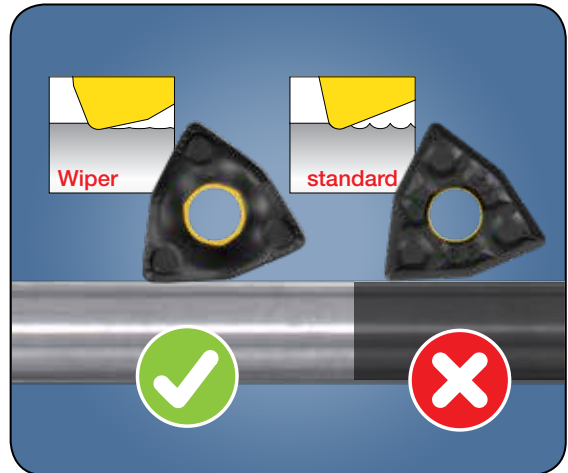

Surface finish using wiper insert

It is better to machine on a smooth area. If needed, use wiper insert to improve surface finish before hard part turning.

Machine, Workpiece and Tool Holder Rigidity and Stability

Rigidity and stability are extremely important when working with PCBN. PCBN cannot be operated under vibrations. As long tool overhang and long part overhang can cause vibrations, the tool and the part overhang must be shortened as much as possible to increase rigidity and stability.

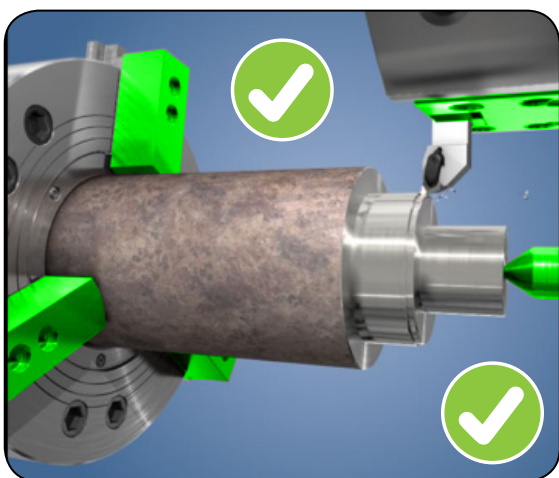

Short tool overhang parts
Short overhang

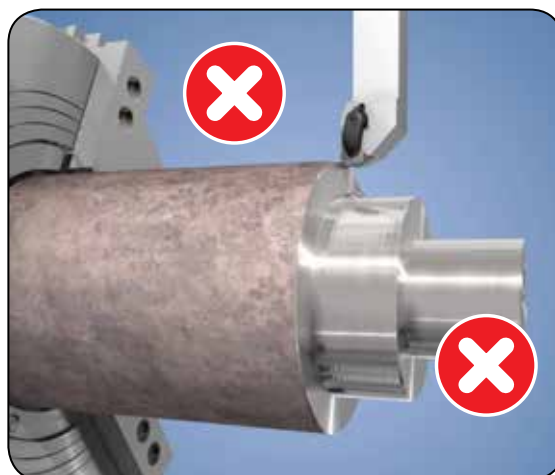

Long tool overhang parts
Long overhang

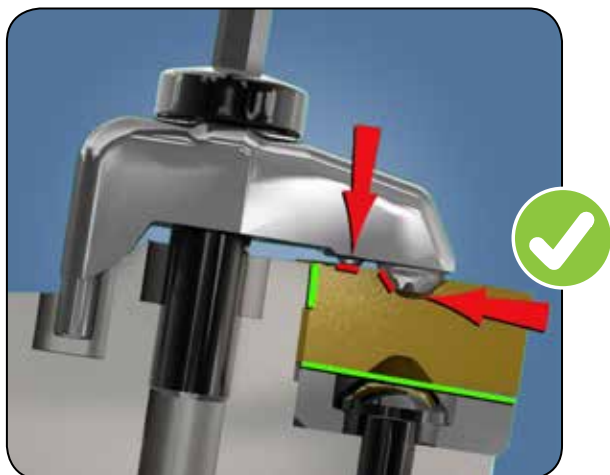

Rigid insert clamping (dimpled)

Insert Clamping

Tool holders with a dimple-clamp mechanism are most recommended for use with PCBN and ceramic inserts. This is due to the stability and rigidity of the insert.

TEST REPORTS



Test Reports

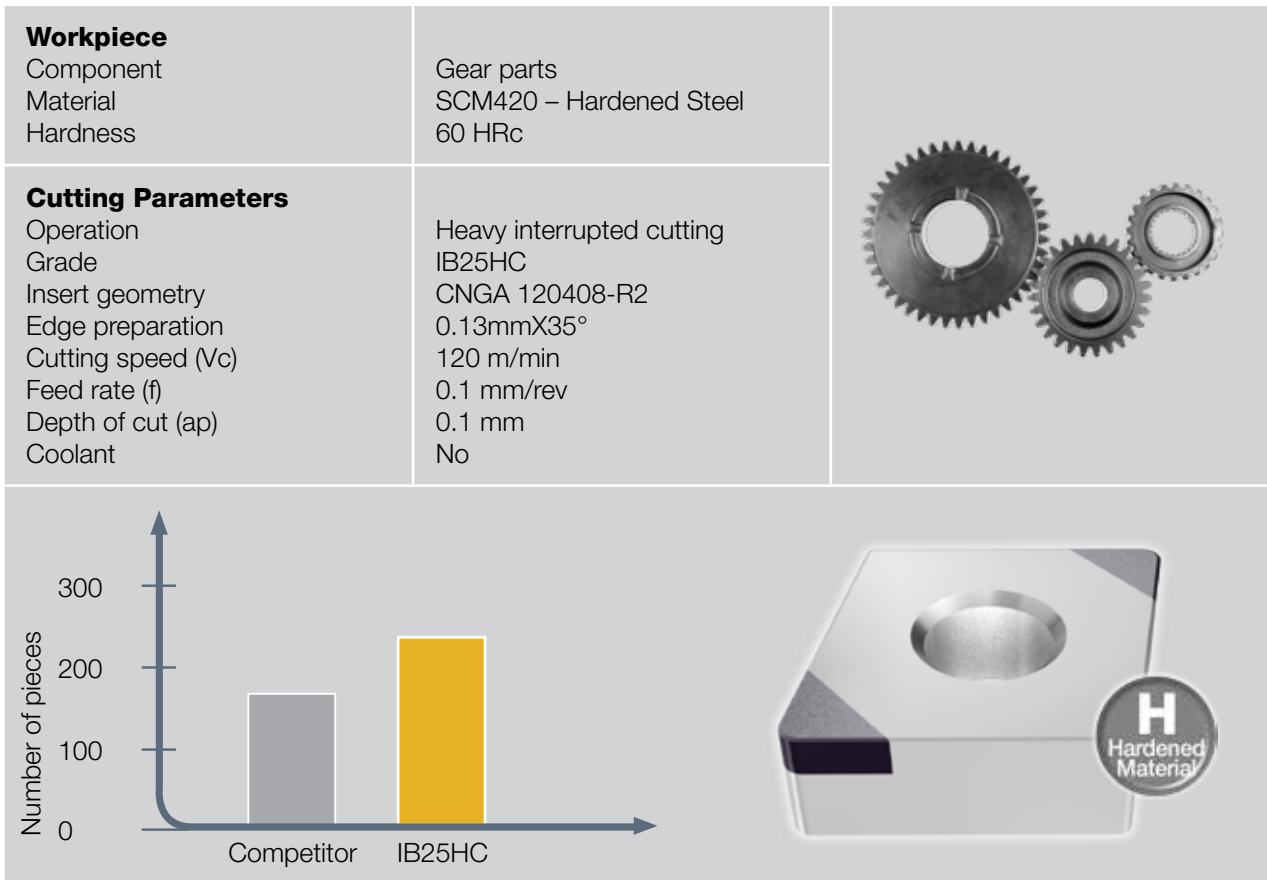
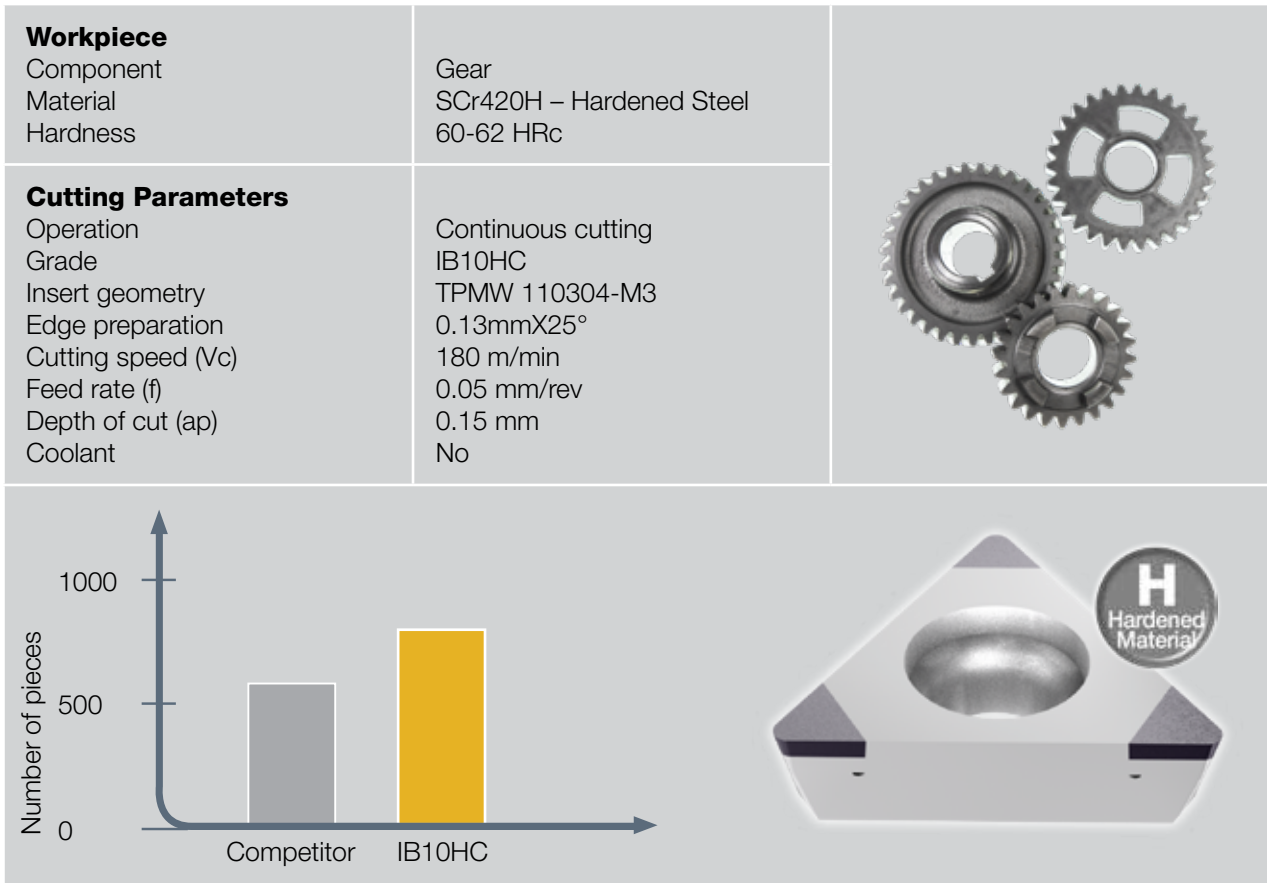

Component Material Hardness	Shaft Hardened Steel 56 HRc	
Cutting Parameters	Operation: Interrupted cutting Grade: IB20H Insert geometry: CNGA 120412-M4 Edge preparation: 0.13mmX25° Cutting speed (Vc): 160 m/min Feed rate (f): 0.2 mm/rev Depth of cut (ap): 0.2 mm Coolant: No	

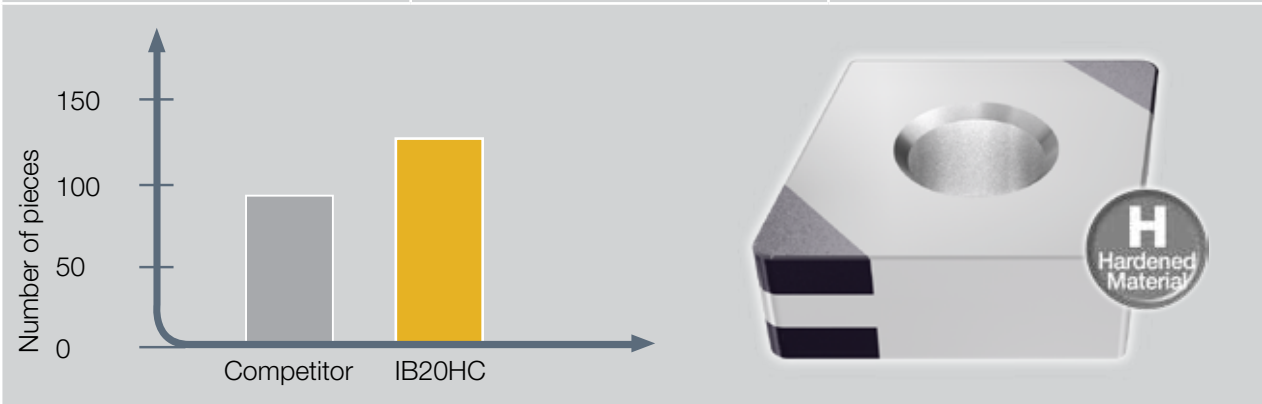

Component Material Hardness	Main Shaft Sintered Metal 50 HRc	
Cutting Parameters	Operation: Continuous cutting Grade: IB05S Insert geometry: DCGW 11T308-M2 Edge preparation: 0.13mmX25° Cutting speed (Vc): 308 m/min Feed rate (f): 0.1 mm/rev Depth of cut (ap): 0.4 mm Coolant: No	

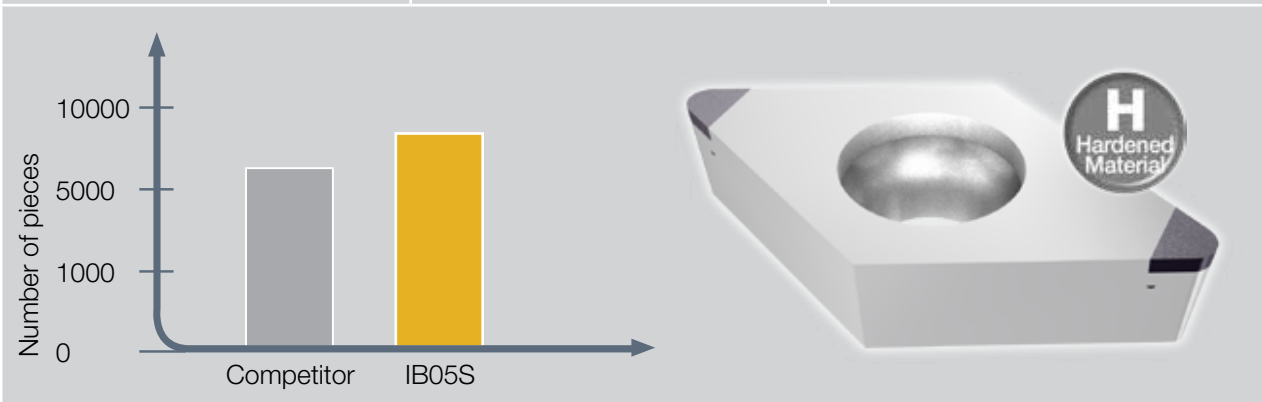

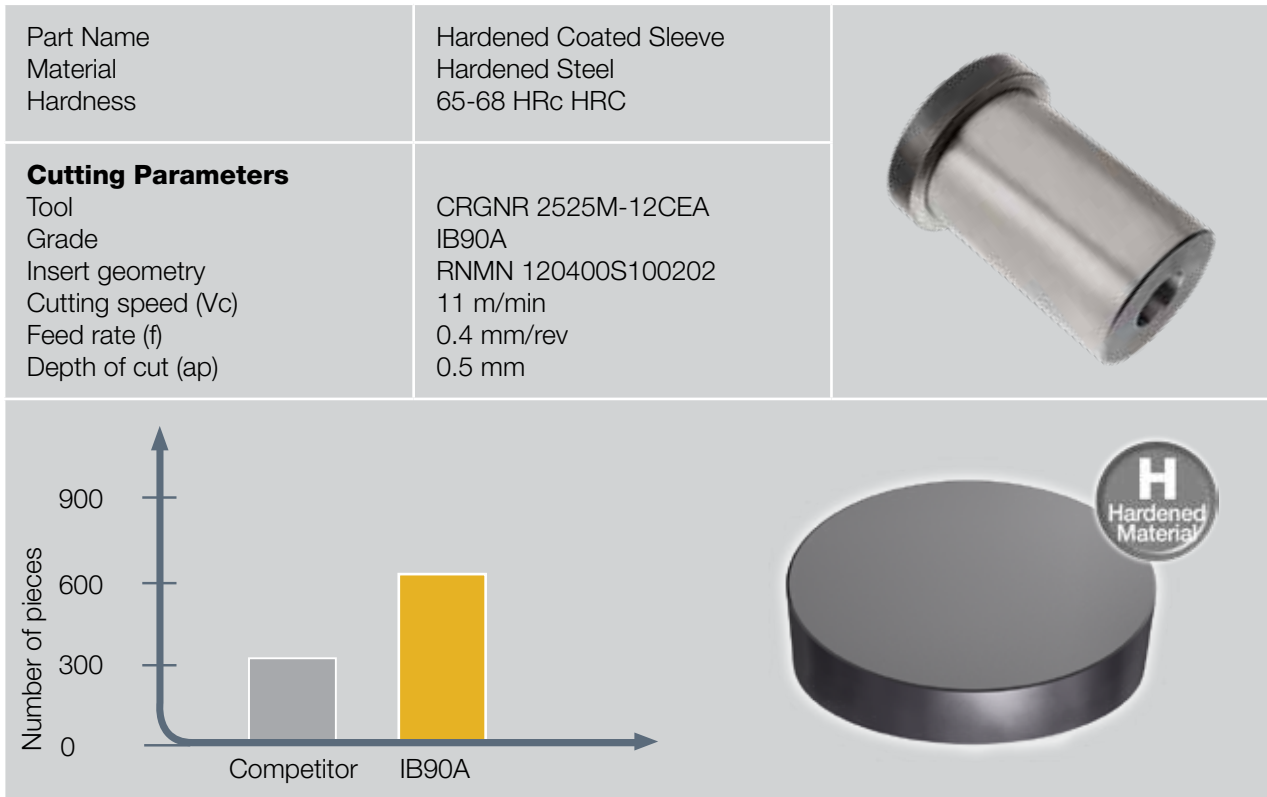

Material	High alloyed steel, cast steel and tool steel	
Hardness	62 HRC	
Cutting Parameters		
Grade	IB50	
Insert geometry	CNGA 120408-2-WGIB50	
Cutting speed (Vc)	200 m/min	
Feed rate (f)	0.15 mm/rev	
Depth of cut (ap)	0.15 mm	

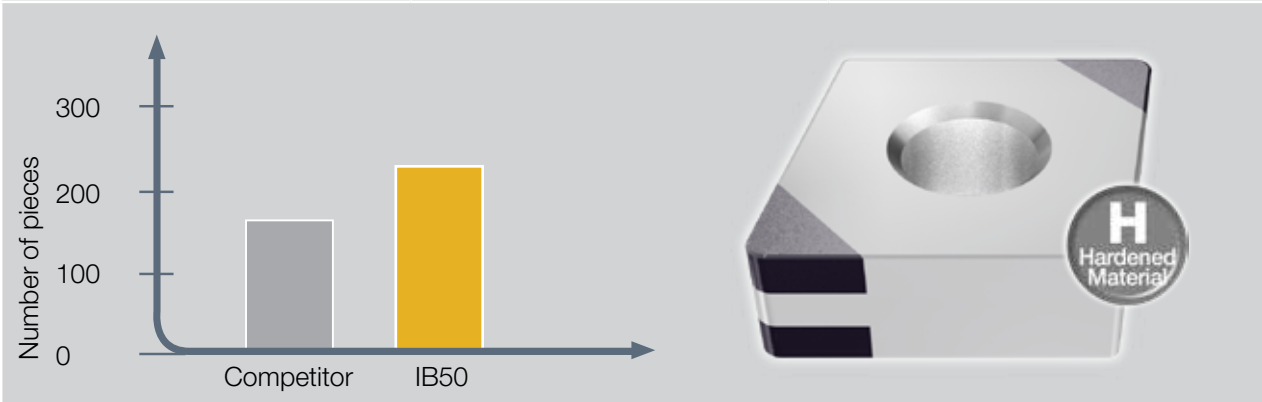

Part Name	Bearing Housings	
Material	Hardened Steel	
Hardness	58-62 HRC	
Cutting Parameters		
Tool	PDJNL 2525M-15	
Grade	IB50	
Insert geometry	DNMA 150612T	
Cutting speed (Vc)	188 m/min	
Feed rate (f)	0.05 mm/rev	
Depth of cut (ap)	0.05 mm	

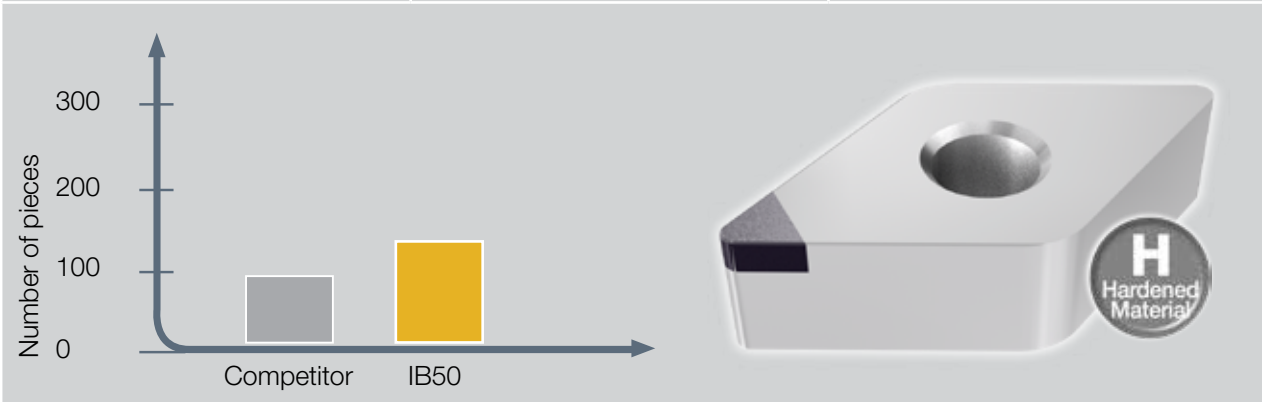

Material Hardness	Hardened steel 58-62 HRC	
Cutting Parameters Grade Insert geometry Cutting speed (Vc) Feed rate (f) Depth of cut (ap)	IB20H CNGA 120408-R2 IB20H 100 m/min 0.1 mm/rev 0.4 mm	

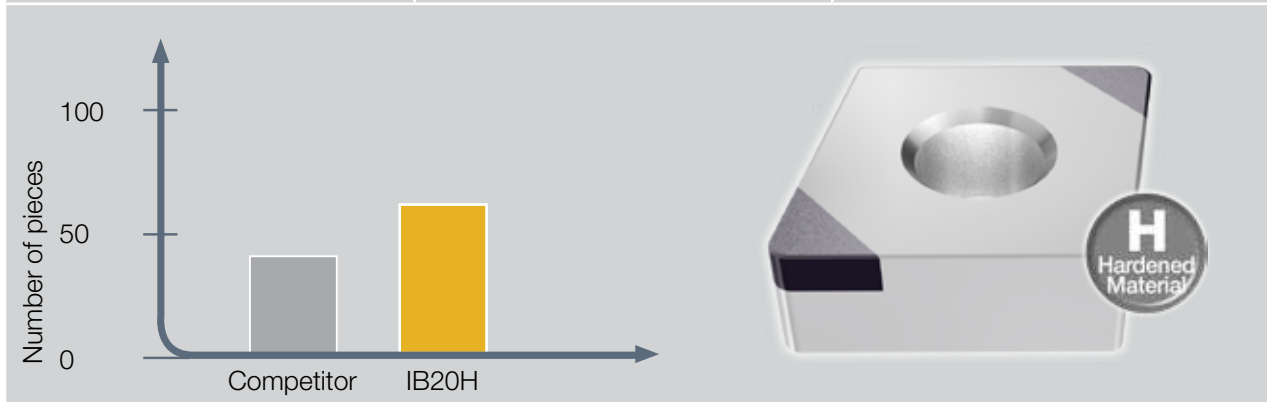

Material Hardness	Hardened steel 60 HRC	
Cutting Parameters Grade Insert geometry Cutting speed (Vc) Feed rate (f) Depth of cut (ap)	IB10HC CCGW 060204-M2 IB10HC 100 m/min 0.07 mm/rev 0.05 mm	

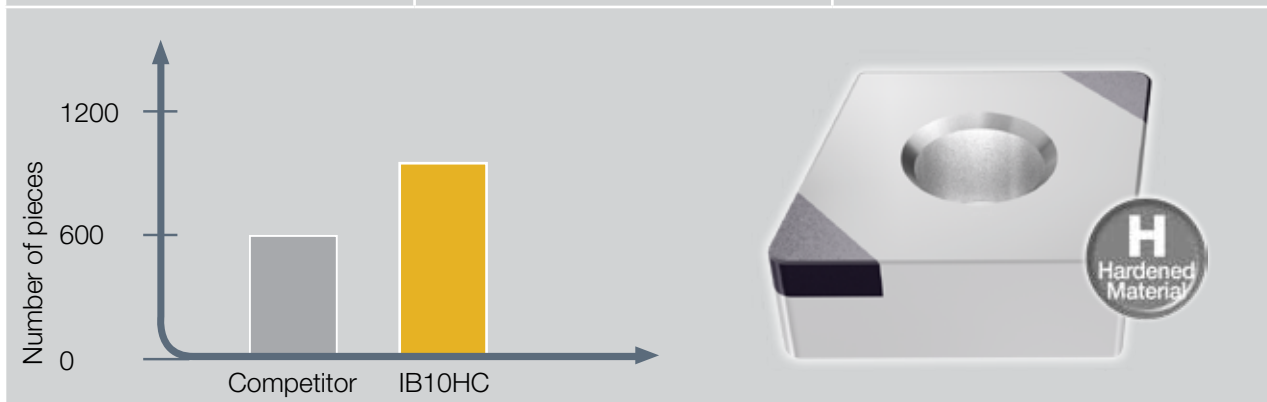

Material Hardness	Pre-Machined 58 HRC	
Cutting Parameters Tool Grade Insert geometry Cutting speed (Vc) Feed rate (f) Depth of cut (ap)	JNL 2525M-15 IB55 DNGA 150608T-MC IB55 150 m/min 0.12 mm/rev 0.17 mm	

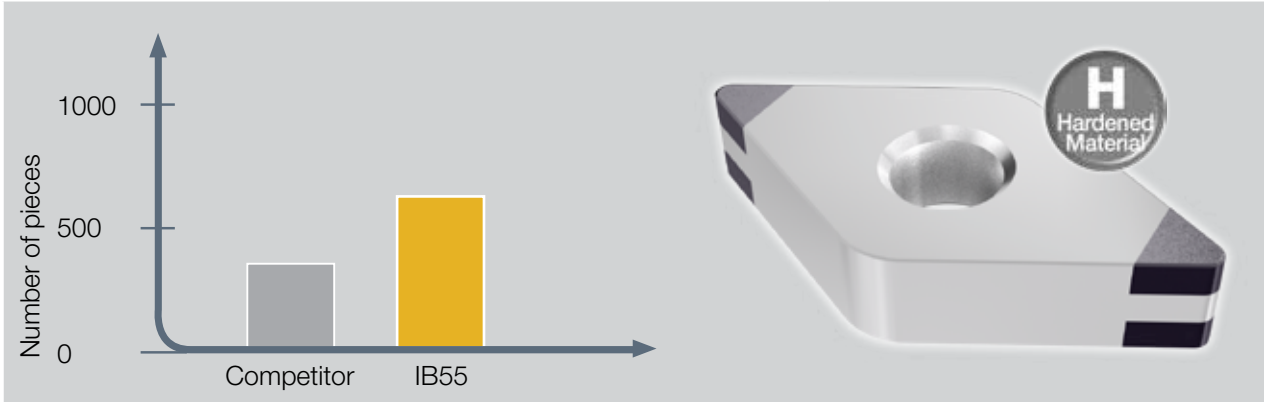

Part Name Material Hardness	Reverse Gear - DQ200 Hardened steel 680 HV	
Cutting Parameters Grade Insert geometry Cutting speed (Vc) Feed rate (f) Depth of cut (ap)	IB10HC CNGA 120412T-WG-2-138529 220 m/min 0.1 mm/rev 0.15 mm	

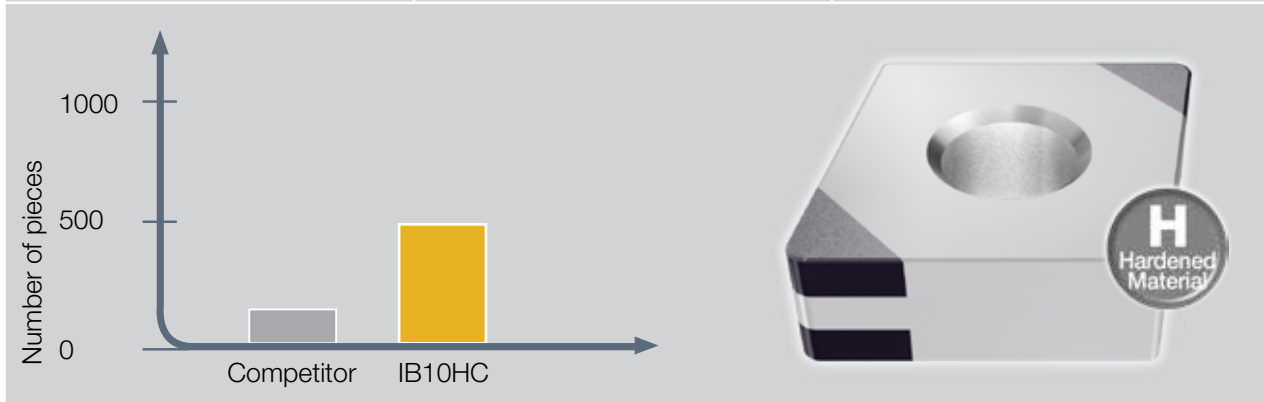

Part Name Material Hardness Type of operation	Gear part 20MnCr5 HRC55-62 Rough turning the D62 hole and internal face turning	
Cutting Parameters Grade Insert geometry Cutting speed (Vc) Feed rate (f) Depth of cut (ap)	IB22HC CNGA 120408T-J IB22HC 110 m/min 0.1 mm/rev 1.4-1.5 mm	

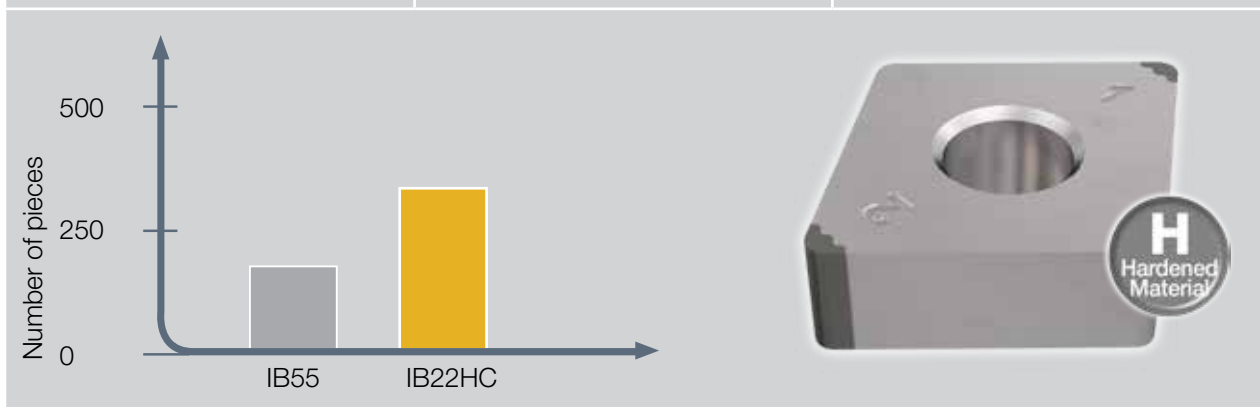



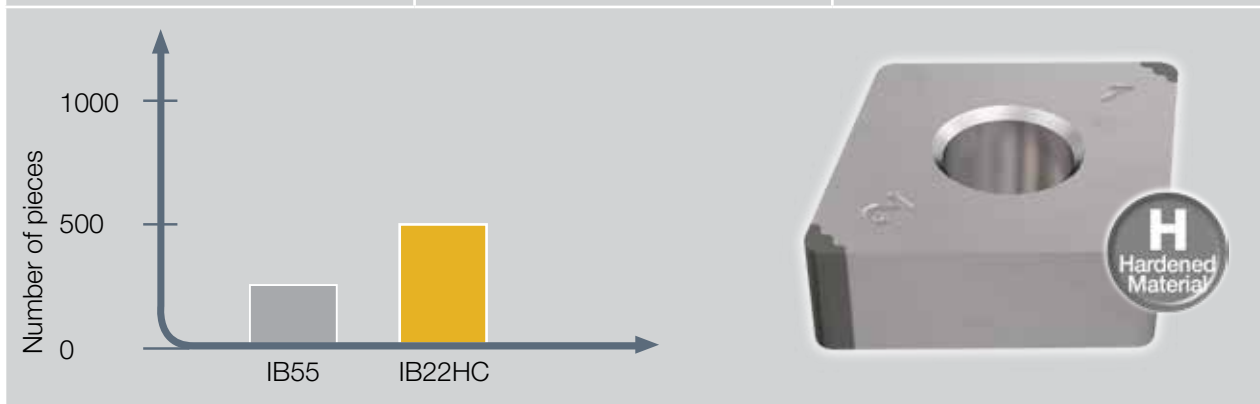

Part Name Material Hardness Type of operation	Gear part 20MnCr5 HRC55-62 Rough boring	
Cutting Parameters Grade Insert geometry Cutting speed (Vc) Feed rate (f) Depth of cut (ap)	IB22HC CNGA 120408T-J IB22HC 110 m/min 0.1 mm/rev 1.4-1.5 mm	

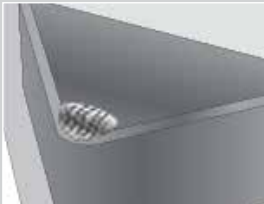

PCBN Insert Wear

Improper use with PCBN inserts can cause premature failure, damage and short tool life. The most common reasons for early failure with PCBN include choosing the wrong grade, using the wrong cutting conditions (speed feed

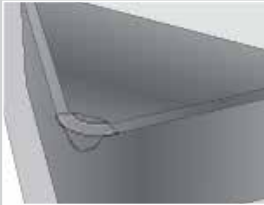
and D.O.C.), and the wrong choice of edge preparation. HTP machining using unstable tools with high overhang and bed part clamping can cause unstable conditions and vibrations during machining.

<p>Crater wear</p> 	<ul style="list-style-type: none"> • Reduce cutting speed • Increase feed • Increase/decrease depth of cut
<p>Flank wear</p> 	<ul style="list-style-type: none"> • Increase cutting speed • Increase feed
<p>Chipping</p> 	<ul style="list-style-type: none"> • Check stability, eliminate vibration • Do not use coolant • Use a stronger cutting edge: <ul style="list-style-type: none"> - S-edge geometry - Increase chamfer size (angle and/or width) - Use larger nose radius
<p>Cracking /fracture</p> 	<ul style="list-style-type: none"> • Use uncoated inserts • Check stability, eliminate vibration • Check/replace shim • Make sure tool is aligned to center • Do not use coolant • Decrease feed • Decrease depth of cut • Use a stronger cutting edge: <ul style="list-style-type: none"> - S-edge geometry - Increase chamfer size (angle and/or width) - Use larger nose radius - Use wiper
<p>Notch wear</p> 	<ul style="list-style-type: none"> • Increase speed • Reduce feed • Reduce/vary depth of cut

PCBN Designation System

ISCAR is introducing a designation system suited especially for PCBN inserts.

The designation system includes indicators for all the important parameters which need to be taken into consideration when choosing a PCBN insert. For example: the number of cutting tips, edge preparation, ISO material family, coating type, etc.

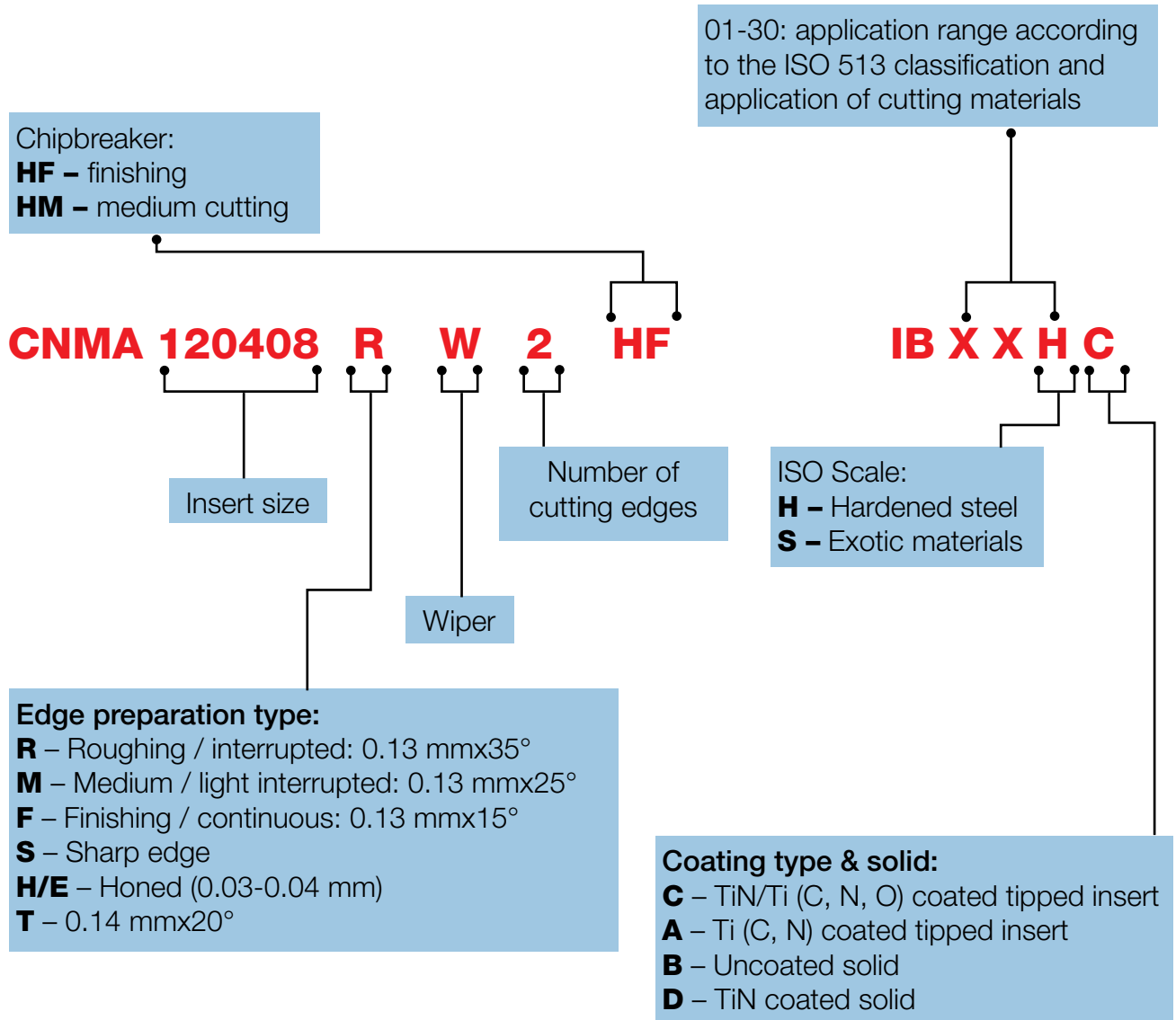

CERAMIC INSERTS



Ceramic Inserts – General Information

Hard materials can be machined also by ceramic cutting tools containing Al_2O_3 or Si_3N_4 .

Ceramic materials have the following properties for hard turning:

- High hardness level
- High wear resistance
- Very good stability in high temperatures
- Low thermal conductivity (heat is transferred to chip)
- Less sensitivity to thermal cracks due to coolant
- Very attractive cost compared to PCBN
- Not recommended for interrupted machining

Ceramic inserts are available as solid ceramic inserts (pressed or grinding) in the following forms:



Solid ceramic insert without hole



Solid ceramic insert with hole



Solid ceramic insert with dimple

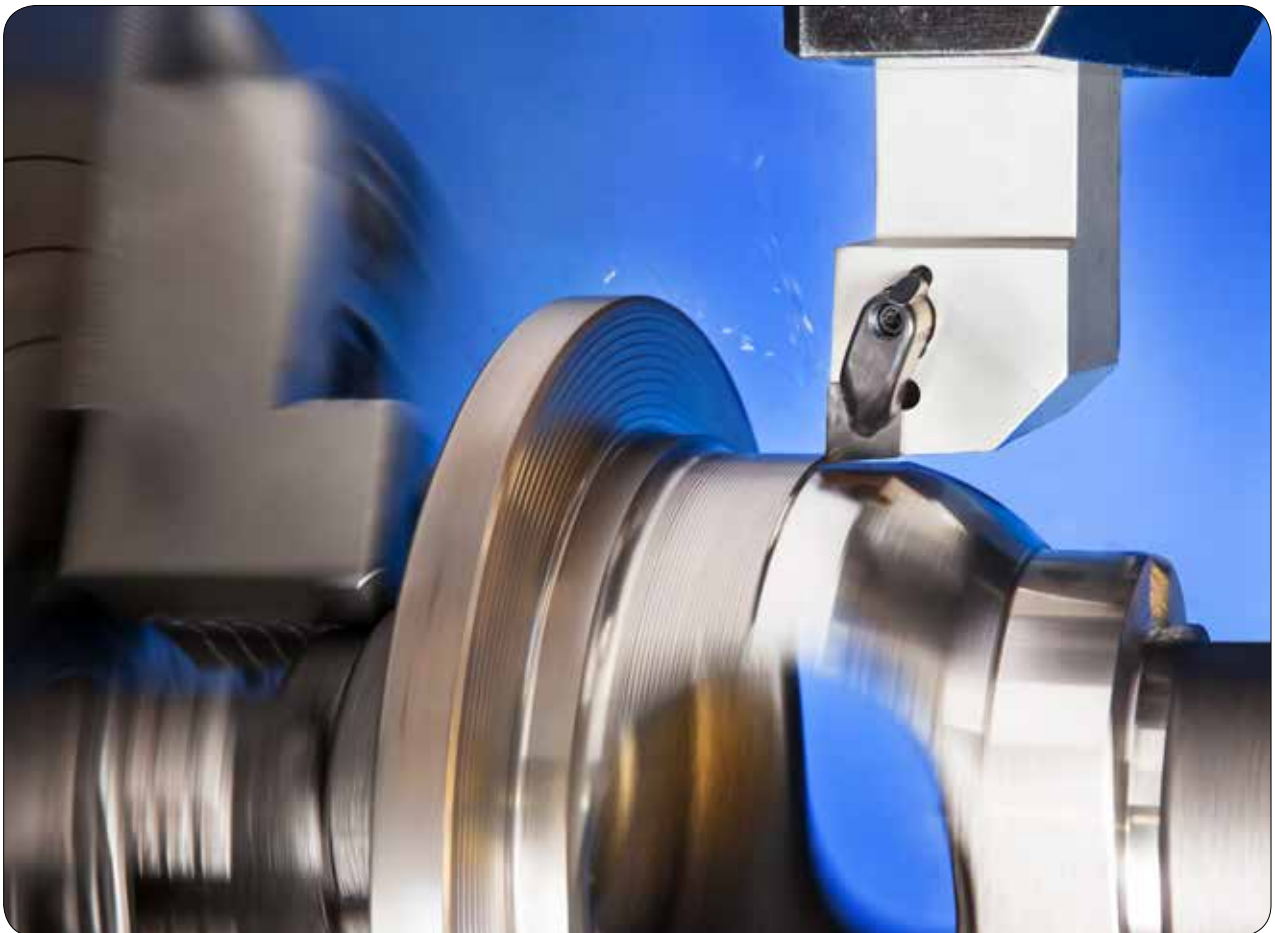

CERAMIC INSERTS



K
Cast
Iron

S
Super
Alloy

H
Hardened
Material



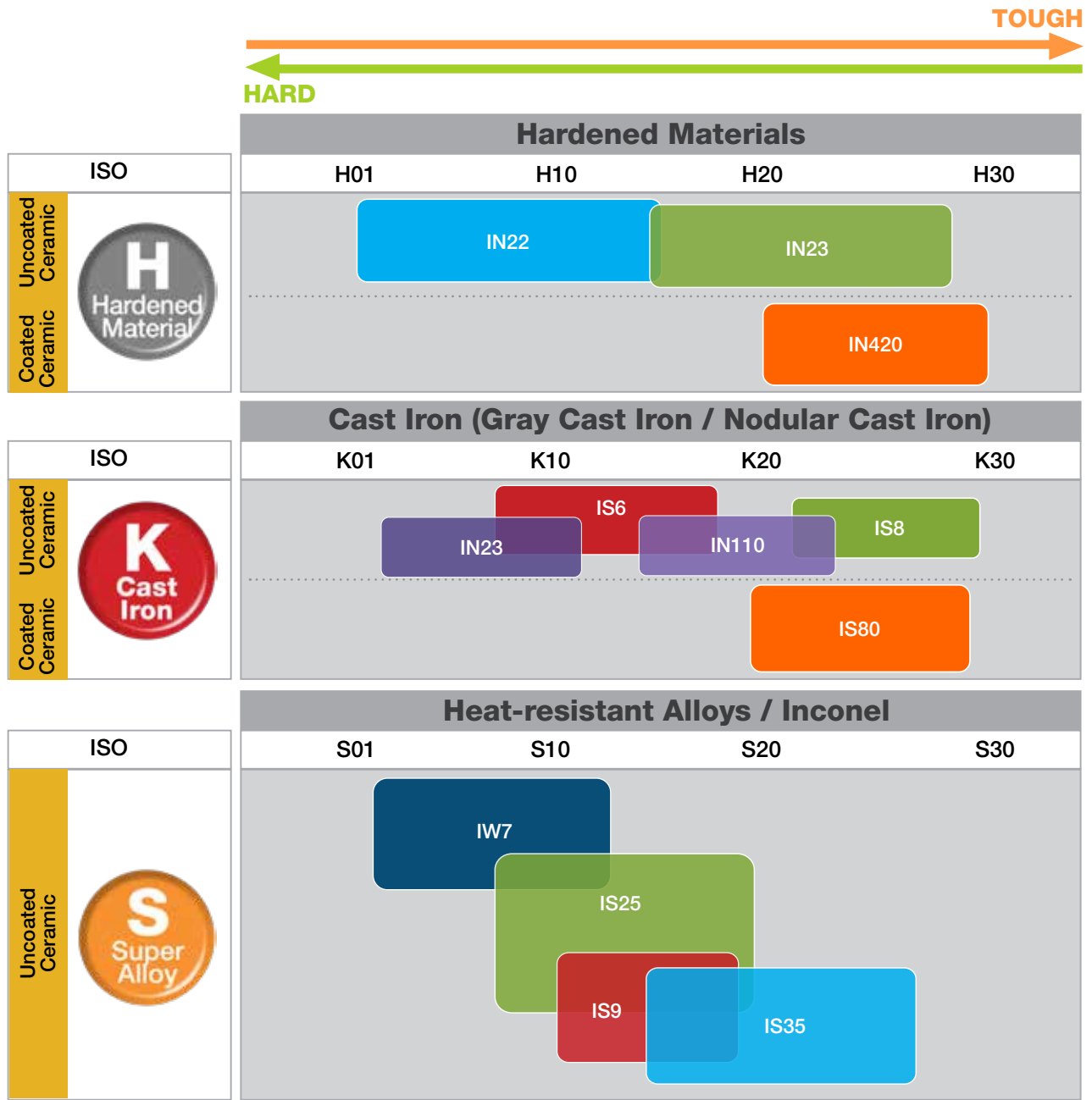



ISCAR Ceramic Grades



Recommended Cutting Conditions for Ceramic Grades

Work Material	Grade	Cutting Mode	Cutting Speed M/Min			Feed mm/rev	Depth of cut mm
			Continuous Cut	Light interrupted	Heavy interrupted		
40-50HRC  50-65HRC	IN22	High speed machining of hardened steel	180-320	180-320		0.1-0.18	0.1-0.5
			50-250	50-250		0.05-0.15	0.1-0.5
	IN23	Machining hardened steel for light interrupted	100-280	100-280		0.1-0.2	0.1-0.8
	IN420	Coated for high speed machining	100-350	100-350		0.05-0.2	0.1-0.6
50-280			50-280				







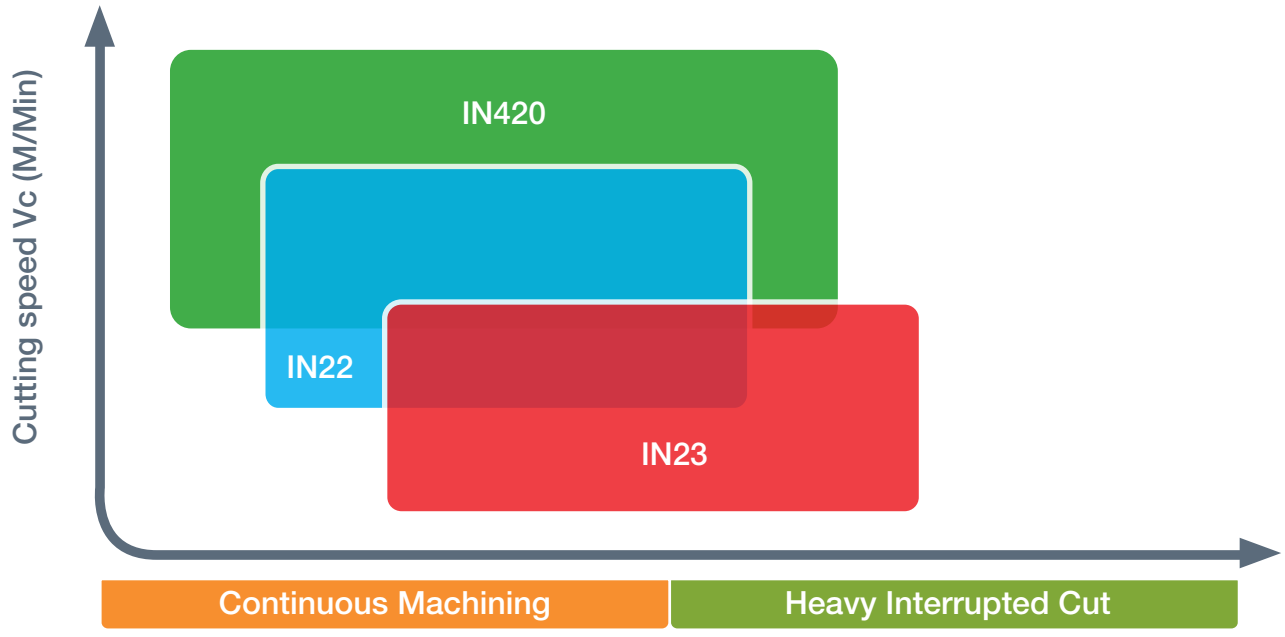

ISCAR Ceramic Grades for Machining Hard Steel

	Grade	Coated/Not Coated	Application	Grade Instruction
Ceramic Grades for Hardened Steel	IN22	N	 	IN22 – Black ceramic, mainly used for high speed machining of light roughing & finishing of hardened steel. Also suitable for finishing operation of chilled cast iron.
	IN420	Y	 	IN420 –Coated, used for high speed finishing machining of hardened steel. Improved tool life up to 50% compared to uncoated grade.
	IN23	N	 	IN23 – Black ceramic, mostly recommended for machining cast iron at finish to medium conditions. Also suitable for light interrupted cut of hardened steel.

 Continuous cut
  Light interrupted
  Heavy interrupted



ISCAR Ceramic Grades for Machining Cast Iron

	Grade	Coated/Not Coated	Application	Grade Instruction
Ceramic Grades for Gray Cast Iron	IN110	N		IN110 – White ceramic features high toughness and wear resistance, used for high speed turning of cast iron, especially high speed dry machining of cylinder liner.
	IN23	N		IN23 – Black ceramic mostly recommended for machining cast iron at finish to medium conditions. Also suitable for light interrupted cut of hardened steel.
	IS6	N	 	IS6 – (SiAlON), High fracture toughness and thermal shock resistance. Used for very high speed machining (up to 1200 m/min) roughing to finishing of cast iron, especially for automotive parts.
	IS8	N	 	IS8 - High wear resistance with good toughness and thermal shock resistance. Used for high speed machining roughing to finishing of cast iron.
	IS80	Y	  	IS80 (CVD coated) - High wear resistance with good toughness and thermal shock resistance. Used for high speed machining roughing to finishing of cast iron.

 Continuous cut

 Light interrupted

 Heavy interrupted



Recommended Cutting Conditions for Ceramic Grades





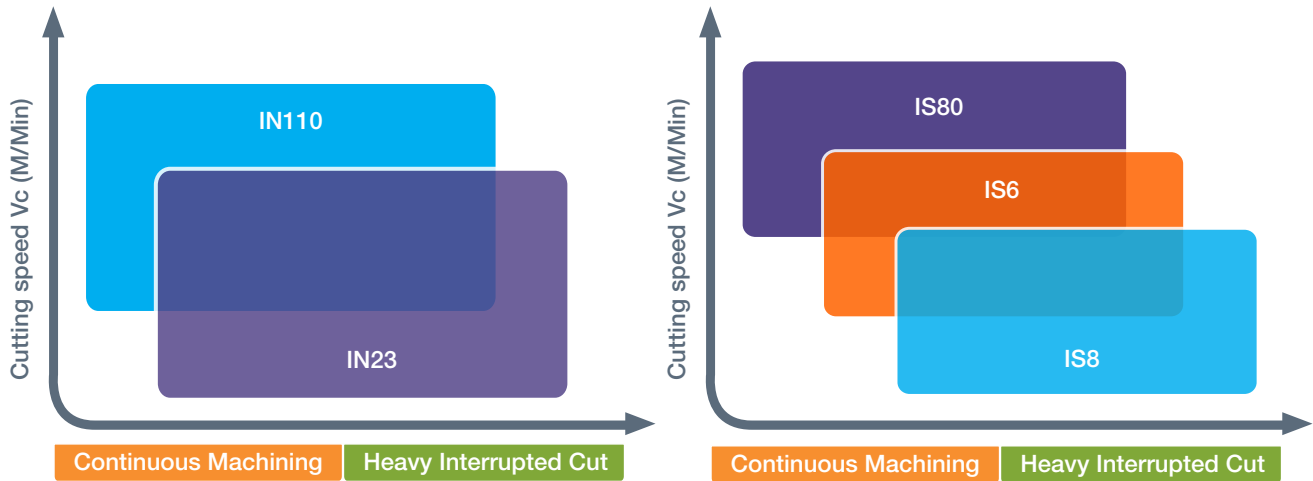

Work Material	Grade	Cutting Mode	Cutting Speed M/Min			Feed mm/rev	Depth of cut mm
			Continuous Cut	Light interrupted	Heavy interrupted		
	IN110	High toughness for high speed of cast iron	400-850			0.1-0.3	0.5-2.0
	IN23	Black ceramic for finish and medium conditions	400-800			0.1-0.4	0.5-2.0
	IS6	For very high speed machining roughing to finishing	400-700	400-700	400-700	0.2-0.6	0.1-3.5
	IS8	High wear resistance for roughing to finishing of cast iron	400-600	400-600	400-600	0.2-0.6	0.1-4.0
	IS80		400-800	400-800	400-800	0.2-0.6	0.1-3.5



*Recommended mainly for ductal iron



ISCAR Ceramic Grades for Machining Super Alloys

	Grade	Coated/Not Coated	Application	Grade Instruction
Ceramic Grades for Super Alloys	IW7	N		Whisker-reinforced ceramic grade, provides high hardness with excellent toughness for machining Ni based high temperature alloys such as Inconel, Waspaloy etc.
	IS25	N		Reinforced SiAlON composite grade, excellent for machining Ni based high temperature alloys such as Inconel, Waspaloy etc.
	IS9	N		A very tough grade with high cutting edge stability. Used for roughing to finishing applications on Ni based high temperature alloys and ductile cast iron.
	IS35	N		SiAlON ceramic grade, provides high hardness with excellent toughness for machining Ni based high temperature alloys such as Inconel, Waspaloy etc. Suitable for high feed rate and depth of cut.

 Continuous cut
  Light interrupted
  Heavy interrupted

Recommended Cutting Conditions for Ceramic Grades

Work Material	Grade	Cutting Mode	Cutting Speed M/Min			Feed mm/rev	Depth of cut mm
			Continuous Cut	Light interrupted	Heavy interrupted		
	IW7	Excellent toughness for machining Ni based alloys	200-400			0.1-0.3	0.5-2.5
	IS25	SiAlON grade for Ni based alloys	200-350			0.1-0.4	1.0-4.0
	IS9	Tough grade for rough and finish applications	180-230	180-230		0.1-0.3	1.0-3.0
	IS35	SiAlON grade with excellent toughness for Ni based alloys	150-250			0.2-0.5	1.0-4.5

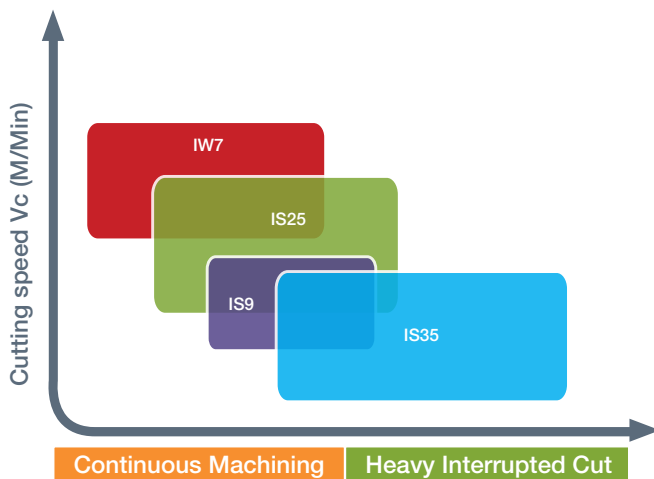

Ceramic – Edge Preparation

Ceramic insert edge preparation is defined by length “L” and angle “Alfa” as in the PCBN line. In addition to the standard range of edge preparations for each grade, different edge preparations can be produced for special inserts if required.



Edge Preparation – Ceramic Standard Line

Grades	IN110	IN420	IN22	IN23	IS6	IS80	IS8	IW7	IS9	IS25	IS35
T(mm)	0.2	0.2	0.2	0.2	0.2	0.2	0.2	0.1	0.1	0.1	0.1
α	20°	25°	25°	25°	25°	25°	25°	20°	25°	20°	20°
Honing only								E	E	E	E
T-Land + Honing										TE	TE

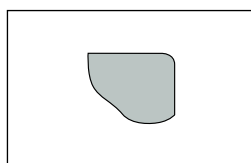

E For semi-finishing and finishing
 $f < 0.2$ mm/rev
 $E=0.03-0.04$ (honing)

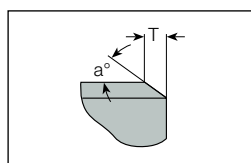

T For semi-roughing and roughing
 $f > 0.2$ mm/rev
 $T=0.1 \times 20^\alpha$

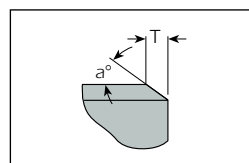

TE

- For roughing and interrupted cut
 $f > 0.2$ mm/rev
- $TE=0.1 \times 20^\alpha + 0.01-0.02$ (honing)

TEST REPORTS

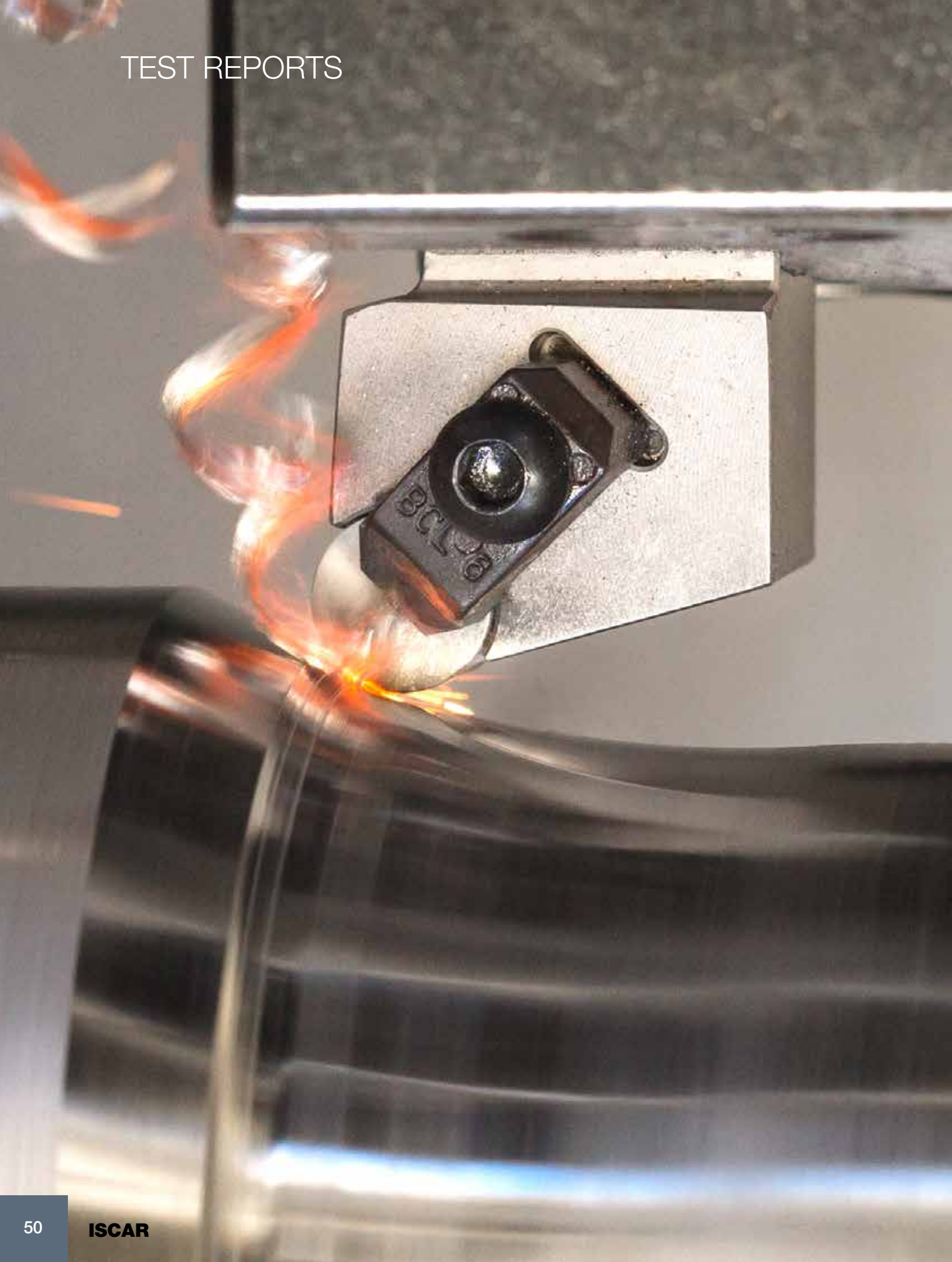

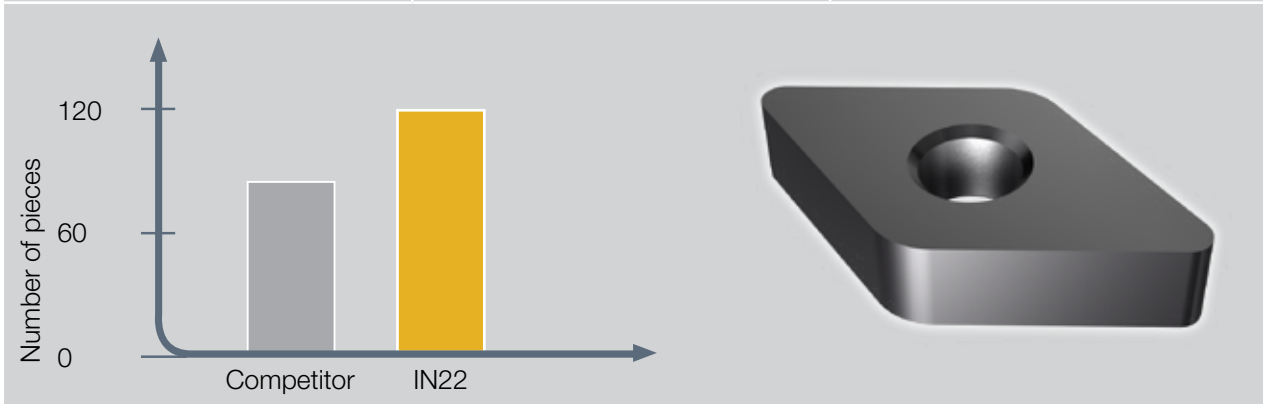

Test Reports

Workpiece Material Hardness	Steel and cast steel 60 HRC	
Cutting Parameters Grade Insert geometry Cutting speed (Vc) Feed rate (f) Depth of cut (ap)	IN22 VNGA 160404T IN22 135 m/min 0.04 mm/rev 0.2 mm	

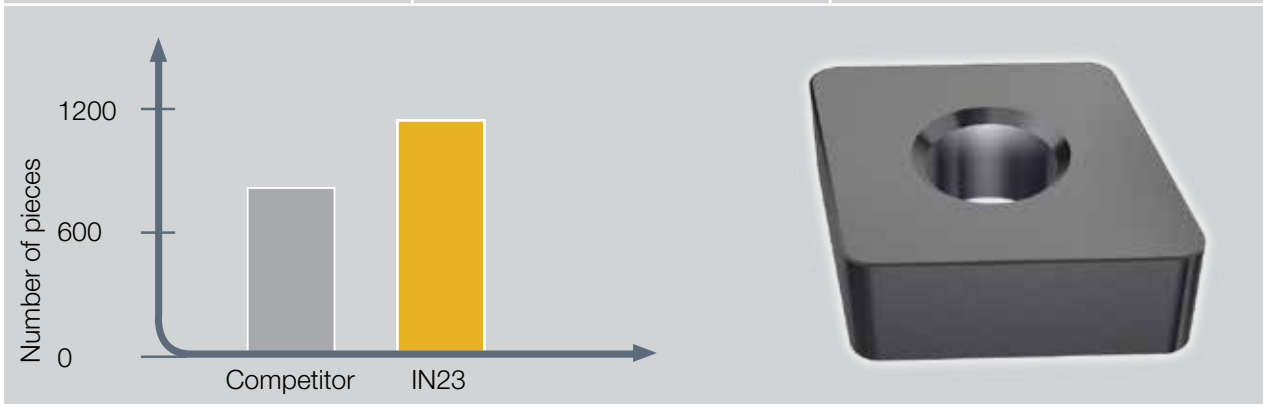

Workpiece Material Hardness	Steel and cast steel 58HRC	
Cutting Parameters Grade Insert geometry Cutting speed (Vc) Feed rate (f) Depth of cut (ap)	IN23 CNGA 431 T 366 m/min 0.02 mm/rev 0.15 mm	



<p>Workpiece Material Hardness</p>	<p>High alloyed steel, cast steel 46 HRC</p>	
<p>Cutting Parameters Grade Insert geometry Cutting speed (Vc) Feed rate (f) Depth of cut (ap)</p>	<p>IN420 CNGA 120412T IN420 140 m/min 0.1 mm/rev 1.5 mm</p>	

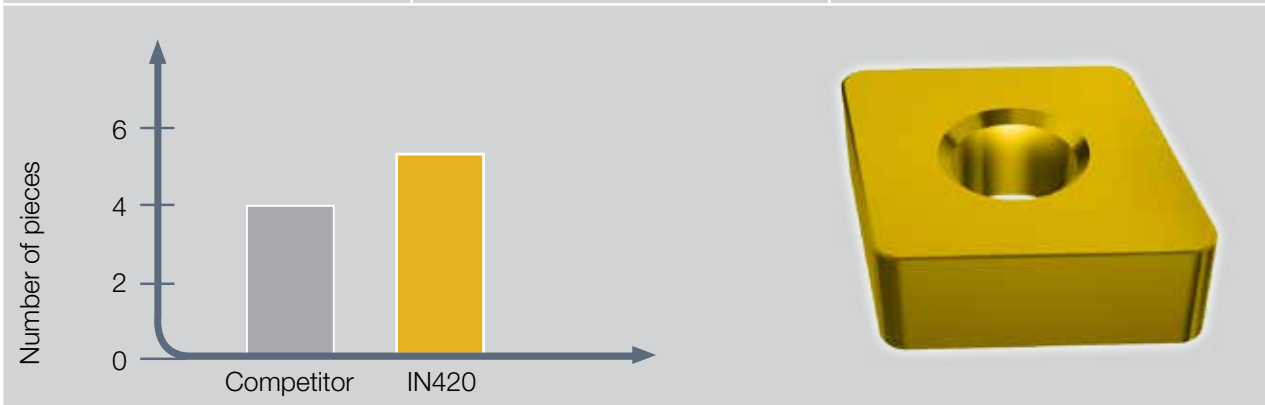

<p>Workpiece Material Hardness</p>	<p>Super alloys</p>	
<p>Cutting Parameters Grade: Insert geometry Cutting speed (Vc) Feed rate (f) Depth of cut (ap)</p>	<p>IS35 RNGN 120700 220 m/min 0.12 mm/rev 2 mm</p>	

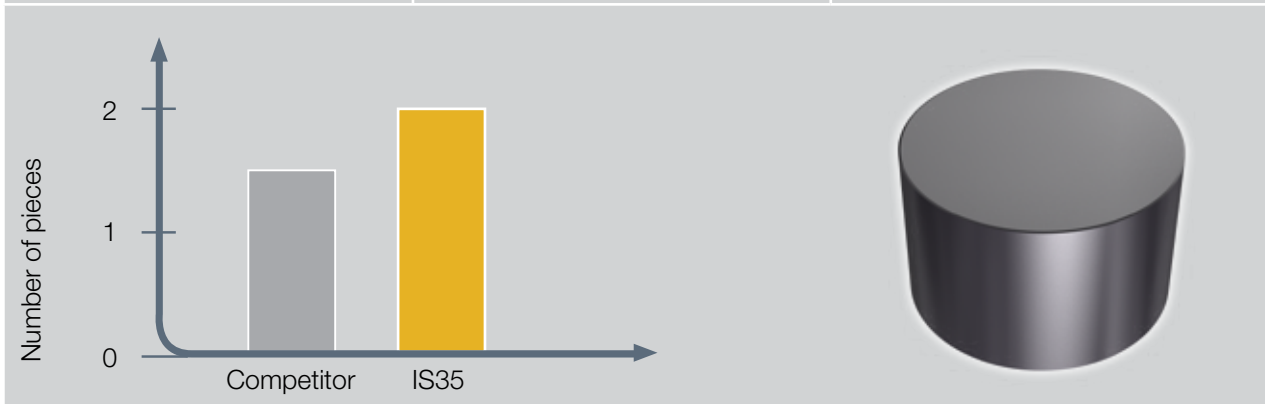

PCD INSERTS





PCD

PCD has become a global industry standard for enhanced part quality and significant cost reductions in the overall production cycle.

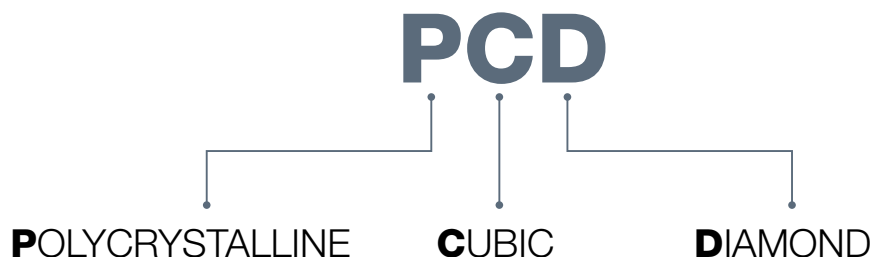

Non-Ferrous Machining

When it comes to non-ferrous materials processing such as aluminum alloys, titanium, carbon fiber, reinforced plastics, ceramic and other non-metallic materials, PCD (polycrystalline cubic diamond) is an advanced material that significantly reduces machining time and provides excellent surface quality due to excellent abrasion resistance and low coefficient of friction.

PCD has a high thermal conductivity and good heat dissipation from the cutting area. PCD possesses the highest flexural strength of all cutting materials. PCD is very well adapted for aluminum machining with high Si content or other abrasive filler materials. Temperature hardness up to approx. 650 °C.



High grinding efficiency, low grinding force: Less heat will be generated by the hole in the grinding process. This can decrease or prevent burns and cracks on the surface of the workpiece, and decrease the equipment's wear and energy consumption.

High wear resistance: Diamond grinding tools' change in dimension is small. This can lead to good grinding quality and high grinding precision.

Long lifespan, long dressing period: This can greatly increase work efficiency and decrease the product's labor intensity.
Low comprehensive cost: The processing cost of each workpiece is lower.

Materials on Hardness Scales

PCD is characterized by a hardness that is comparable to natural diamond, and it can achieve hardness of 6000HV and more.

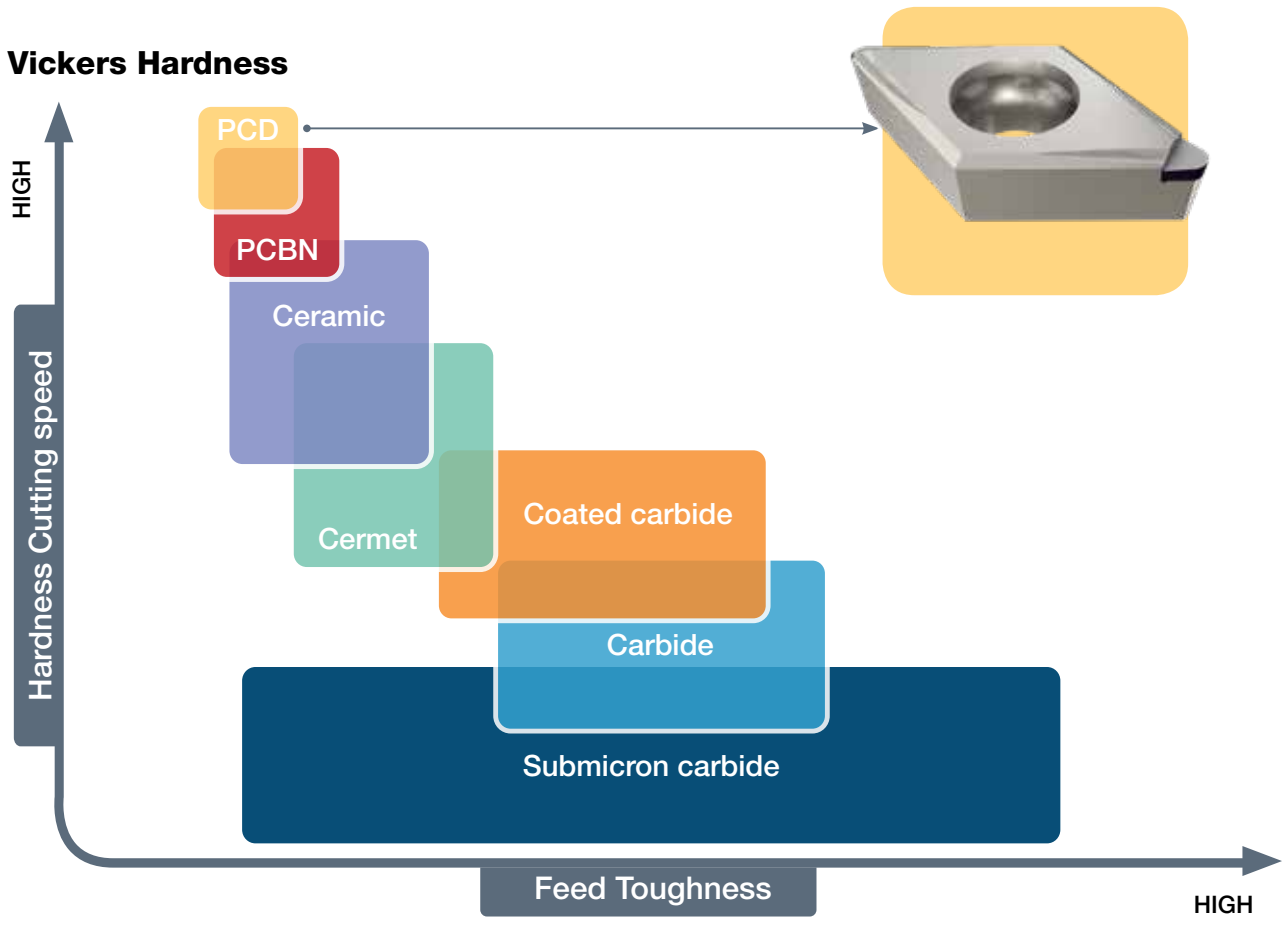

Recommended Cutting Conditions for PCD Grades

Work Material	Grade	Cutting Speed (m/min)	Feed (mm/rev)	Depth of cut (mm)
Al alloy (4-9% Si)	ID5	800-2500	0.1-0.3	0.05-0.3
Al alloy (9-14% Si)	ID5, ID6	600-1300	0.1-0.3	
Al alloy (14-18% Si)	ID5, ID6	300-600	0.1-0.3	
Cemented Carbide	ID5, ID6	20-40	0.05-0.2	0.02-0.5
Wood	ID5, ID4	1000-5000	0.1-0.5	0.2-5.0
Cu alloy	ID5	600-1000	0.05-0.2	0.05-3.0
Plastic, FRP	ID5, ID4	300-1000	0.05-0.25	0.05-3.0

* ID4 and ID6 grades can be offered as special options.



Test Reports

Workpiece Material Hardness	DIN AlMg1	
Cutting parameters Grade Insert geometry Cutting speed (Vc) Feed rate (f) Depth of cut (ap)	ID5 VCGW 160408-T2030 ID5 2,500 m/min 0.15 mm/rev 0.5 mm	

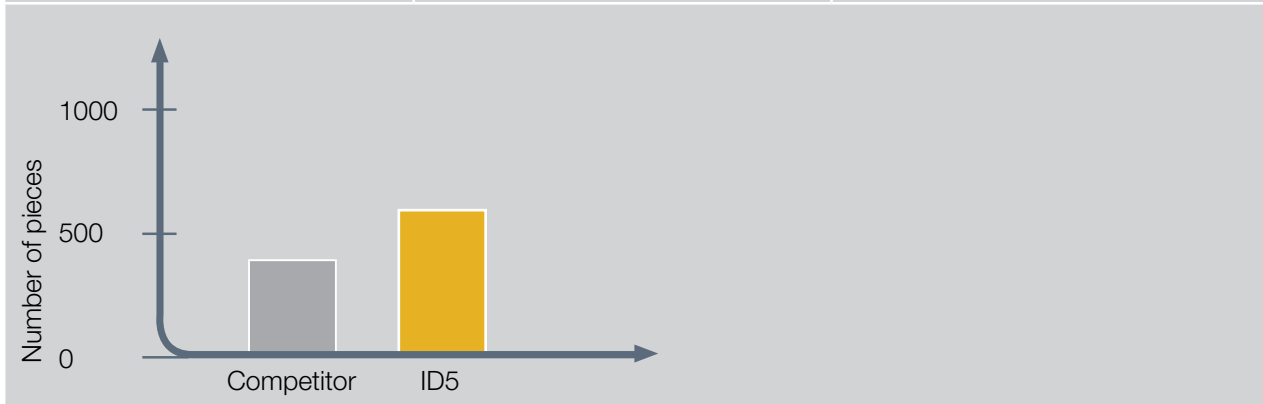

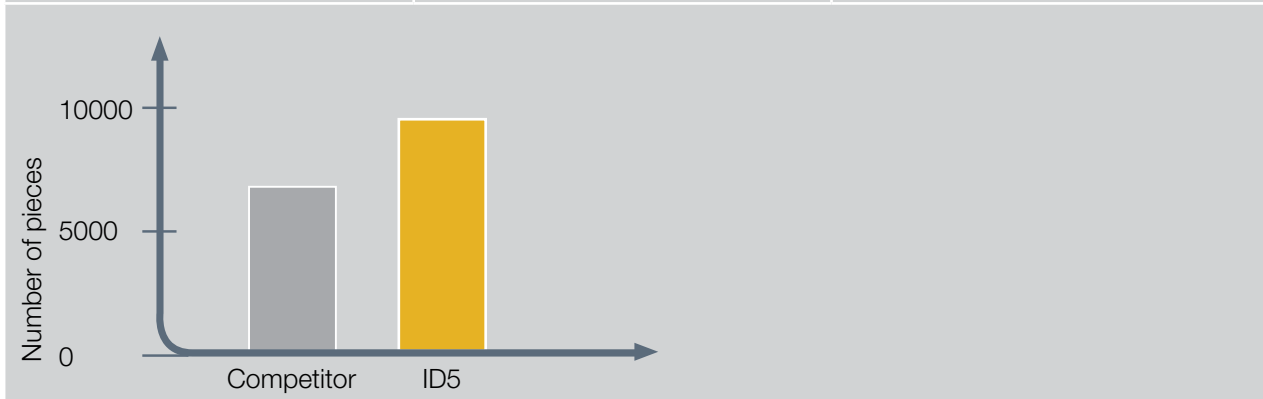

Workpiece Material Hardness	Aluminum - cast, alloyed 130 HB	
Cutting parameters Grade Insert geometry Cutting speed (Vc) Feed rate (f) Depth of cut (ap)	ID5 VCGT 160408-DW 2,873 m/min 0.45 mm/rev 1 mm	



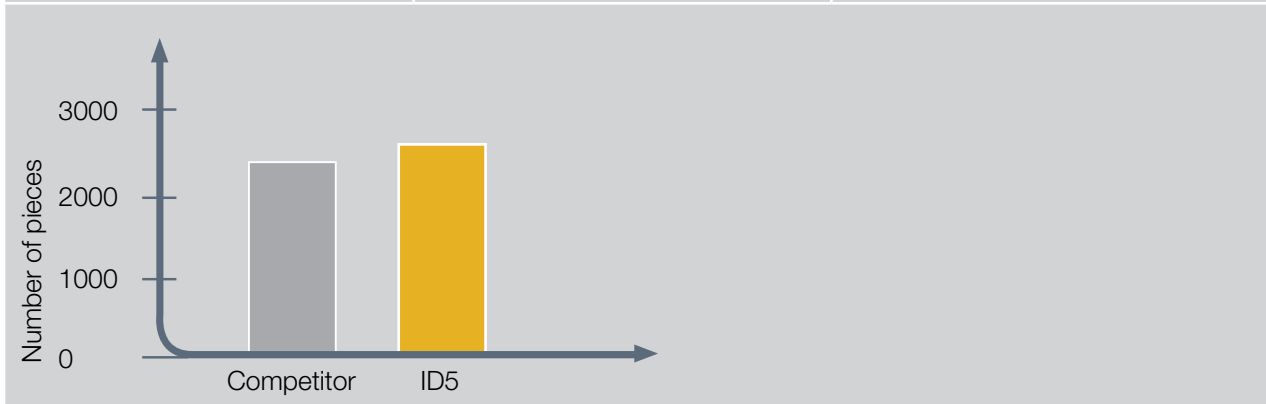

Workpiece Material Hardness	Copper alloys	
Cutting Parameters Grade Insert geometry Cutting speed (Vc) Depth of cut (ap)	ID5 CCMT 060204D ID5 313 m/min 0.15 mm	



Workpiece Material Hardness	Aluminum - cast, alloyed 100-130 HB	
Cutting Parameters Grade Insert geometry Cutting speed (Vc) Feed rate (f) Depth of cut (ap)	ID5 GIDA 804-2205 ID5 746 m/min 0.1 mm/rev 0.2 mm	

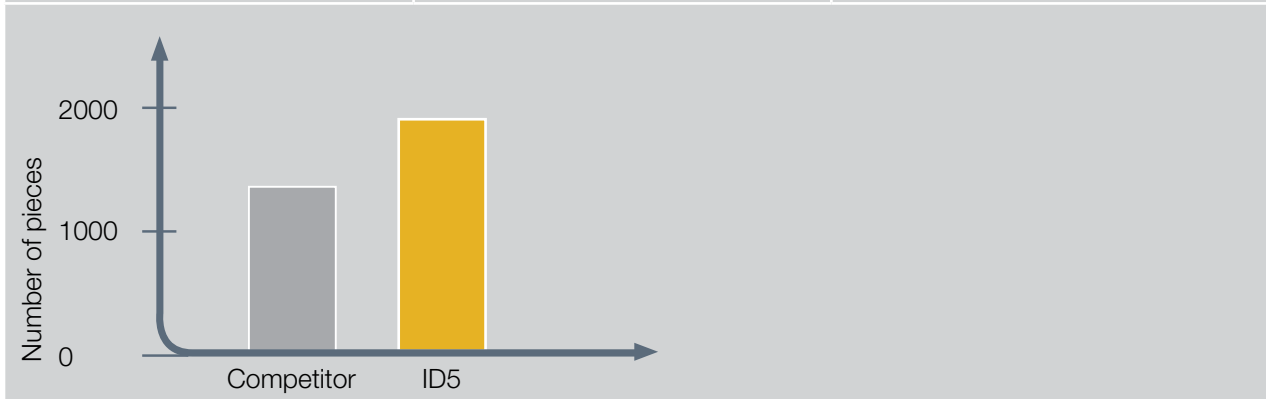

Grade Comparison

PCBN

ISO Classification	ISO Symbol	ISCAR	Tungaloy	Mitsubishi	Sumitomo	Sandvik	Kyocera	Dijet	NTK	Seco Tools	Kenna-metal	TaeguTec	Widia	Walter	Geratizit
K	K01	IB10K	BX930 BX910 BX870	MB710 MB730 MB5015	BN500 BNC500	CB7525 CB7050 CB50	KBN60M	-	B52	-	KB9610 KD120 KB1630	KB90	WBH10C	WCB80	TA100 CTL3215
	K10	IB05S IB10S	BX470 BX480 BX950	MB710 MB730	BN7000 BN7500 BN500 BNC500	CB7050 CB7925 CB50	KBN60M	JBN795	B23 B30 B52	CBN200 CBN300 CBN400C CBN010	KB9640 KD120 KB1630	KB90A	WBK40U	WCB80 WCB50	TA120 TA201 CTL3215
	K20	IB90A IB90 IB25KD	BXC90 BX90S	MB730 MBS140	BNS800	CB7050	KBN900	-	B23 B30 B52	CBN300 CBN500 CBN600 CBN010	KB1340 KB1345	-	WBK45U	WCB80	CTL3215
	K30	IB90A IB25KD	BXC90 BX90S	MBS140	BNS800	-	KBN900	-	B16	CBN500 CBN600	KB1340 KB1345	-	-	-	-
S	S01	IB05S	M714B	MB730	BN350	-	-	JBN795	JP2	CBN170	-	KB90	-	-	-
	S10	IB05S IB90	BX470 BX480 BX950	MB4020	BN7500	CB7050	KBN65B KBN65M	-	B23 B30	CBN200	KB1630	KB90A	WBK45U	WCB80	TA201
H	H01	IB05H IB10HC	BXM10 BX310	BC8110 MBC010 MB810	BNC100 BNC160 BNC2010 BNX10 BN1000	CB20	KBN510 KBN10C KBN05M KBN10M	-	B52 B5K	CBN10 CBN100 CBN160C CBN050C	KB1610 KB5610	KB50	WBH10C	WCB30	-
	H10	IB50 IB55 IB10H IB10HC IB20H IB25HA	BXM10 BX330 BX530	BC8110 MBC020 MB8025	BNC160 BNC200 BNC2020 BN250 BN1000	CB7015 CB7025 CB20 CB50	KBN525 KBN05M KBN10M KBN25M	JBN245	B36 B52 B6K	CBN150 CBN200 CBN300 CBN060K CBN050C CBN160C CBN300P CBN400C	KB9610 KB1610 KB5610	KB50 TB650	WBH10C WBH10P WBH10U	WCB30 WCB50	CTL3215 TA100
	H20	IB20H IB20HC IB25HA IB25HC	BXM20 BXA20 BX360	MBC020 BC8120 MB8025 MB825	BNC200 BNC2020 BN250 BNX20 BNX25 BN2000	CB7025 CB20 CB7035	KBN525 KBN05M KBN10M KBN25M	JBN300 JBN330	B22 B36 B40 B6K	CBN150 CBN200 CBN300 CBN060K CBN160C CBN300P CBN400C	KB5625 KB1625	TB650	WBH25P	WCB50 WCB80	CTL3215 TA120
	H30	IB25HC IB90	BXC50 BX380	MB835	BNC300 BN350 BNX25	CB7525	KBN35M KBN900	JBN300 JBN330	B22 B40	CBN500	KB1630 KB9640	-	WBH40C	-	TA201

*Note: The above table is taken from a publication.

We have not obtained approval from each company.

Grade Comparison

PCD

ISO		ISCAR	Tungaloy	Mitsubishi	Sumitomo	Sandvik	Kyocera	Dijet	NTK	Seco Tools	Kenna-metal	TaeguTec	Widia	Walter	Ceratizit
Classification	Symbol														
N	N01	ID5	DX160 DX180	MD205	DA90	CD10	KPD001	JDA30 JDA735	-	-	KD1400 KD1405 KD100	-	-	WCD10	CTD4125
	N10	ID5	DX140	MD205 MD220	DA150	CD10	KPD001 KPD010 KPD230	JDA715	PD1	PCD05 PCD10	KD100 KD1400 KD1425	KP500	WDN25U	WCD10	CTD4125 CTD4110

*Note: The above table is taken from a publication.
We have not obtained approval from each company.

Ceramic

ISO		ISCAR	Tungaloy	Sumitomo	Sandvik	Kyocera	NTK	Kennametal	TaeguTec	Ceramtec	Walter	Ssang-Yong
Classification	Symbol											
K	k01-k10	IN110	-	-	CC620	KA30	HC1 HW2	-	AW120	SN60 SN80	-	SZ200 SZ300
	k05-k15	IN23	-	NB90S NB90M	CC650	A65	HC2 HC5 HC6	KY1615	AB30	-	-	ST100 SD200 TC100
	k10-k20	IS6	-	SN200K SN2100K	-	-	SX9	KY1310 KY3000 KY300	AS500	SL506 SL508 SL606 SL608	-	-
	k15-k25	IS8	LX11 LX21	SN200K SN2100K NS260	CC6090 CC6091	KS6000 KS6050 KS500	SX1 SX6 SX8	KY1320 KY3500 KYK10	AS10	SL500 SL808	Q130 WSN10	SN26 SN300 SN400 SN500 SN600
IS80		-	NS260C	CC1690	CS7050	SP2 SP9	KY3400 KYK25	SC10	SL550C SL554C SL654C SL658C SL854C SL858C	-	-	
S	s01-s15	IW7	WG300	WX2000	CC670	KXW1	WA1 WA5	KY4300	TC430	-	WWS20	SW500 SW800
	s10-s20	IS25 IS9	WG300	-	-	-	-	KY2100	TC3020 AS20	-	-	-
	s20	IS35	-	-	CC6060 CC6065	KS6040	SX5 SX7 SX9	KY1540 KYS25 KY2100	TC3030	-	-	SN800 SN900
H	H01-H10	IN420	-	NB100C	CC6050	A66N PT600M	ZC4 ZC7	KY4400	AB2010	-	-	TC300
		IN22	LX11 LX21	-	-	-	HC2 HC5 HC7	-	AB20	SH2 SH4	-	ST300 ST500 ST700
		IIN23	LX11 LX21	NB90S NB90M	CC650	A65	HC2 HC5 HC6	KY1615	AB30	-	-	ST100 SD200 TC100

*Note: The above table is taken from a publication.
We have not obtained approval from each company.

TECHNICAL INFORMATION



ISOTURN

WNGA-Ceramic
Double-Sided Flat Rake Ceramic
Inserts for Machining Cast Iron

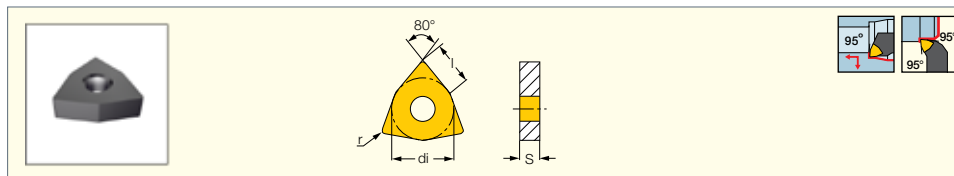

Designation	Dimensions				Tough ↔ Hard			Recommended Machining Data	
	l	di	S	r	IS8	IS80	IS6	ap (mm)	f (mm/rev)
WNGA 080408T	8.70	12.70	4.76	0.80	•			2.00-4.00	0.20-0.60
WNGA 080412T	8.70	12.70	4.76	1.20	•	•	•	2.00-5.00	0.03-0.95

ISOTURN

CNGN-Ceramic
80° Rhombic Double-Sided
Ceramic Inserts with a T-Land for
Machining Cast Iron, Hardened
Steel and Nickel Based Alloys

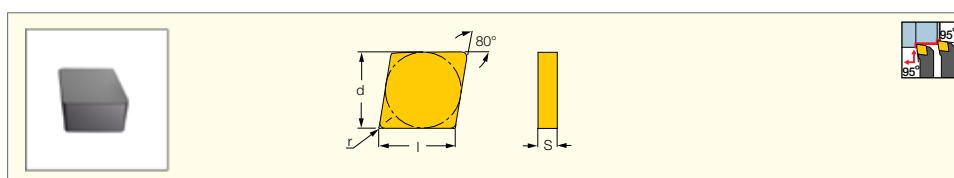

Designation	Dimensions				Tough ↔ Hard							Recommended Machining Data		
	l	di	S	r	IW7	IS35	IS25	IS8	IS80	IN23	IN22	IN420	ap (mm)	f (mm/rev)
CNGN 120404T	12.90	12.70	4.76	0.40	•								1.00-3.00	0.10-0.43
CNGN 120408E	12.90	12.70	4.76	0.80		•				•			1.00-3.00	0.10-0.50
CNGN 120408T	12.90	12.70	4.76	0.80	•			•		•	•		1.00-3.00	0.10-0.50
CNGN 120408T0225-WG ⁽¹⁾	12.90	12.70	4.76	0.80	•								1.00-3.00	0.10-0.50
CNGN 120412E	12.90	12.70	4.76	1.20		•							1.00-5.00	0.10-0.50
CNGN 120412T	12.90	12.70	4.76	1.20	•			•		•			1.00-4.00	0.10-0.50
CNGN 120416T	12.90	12.70	4.76	1.60	•			•	•				1.00-5.00	0.10-0.50
CNGN 120708E	12.90	12.70	7.94	0.80		•							1.00-4.00	0.10-0.50
CNGN 120708T	12.90	12.70	7.94	0.80	•					•			1.00-4.00	0.10-0.50
CNGN 120712E	12.90	12.70	7.94	1.20		•							1.00-5.00	0.10-0.50
CNGN 120712T	12.90	12.70	7.94	1.20	•		•	•					1.00-4.00	0.10-0.50
CNGN 120716T	12.90	12.70	7.94	1.60	•		•	•	•				1.00-5.00	0.10-0.50
CNGN 160612T	16.12	15.88	6.35	1.20				•					1.00-5.00	0.10-0.50

⁽¹⁾ Wiper edge configuration for finishing operations at high feeds

ISOTURN

CNGA-Ceramic
80° Rhombic Double-Sided Inserts
with a T-Land for Machining Cast
Iron and Hardened Steel

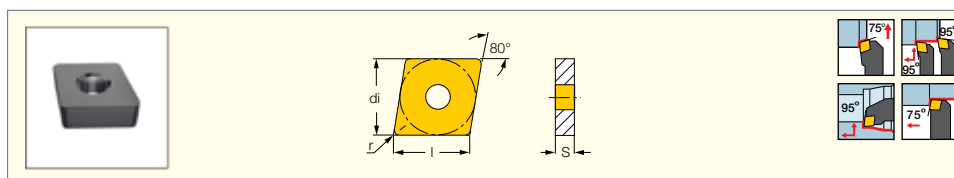

Designation	Dimensions				Tough ↔ Hard						Recommended Machining Data	
	l	di	S	r	IS8	IS80	IS6	IN23	IN22	IN420	ap (mm)	f (mm/rev)
CNGA 120404T	12.90	12.70	4.76	0.40							1.00-3.00	0.05-0.20
CNGA 120408T	12.90	12.70	4.76	0.80	•	•	•	•	•	•	1.00-4.00	0.05-0.20
CNGA 120412T	12.90	12.70	4.76	1.20	•		•	•	•	•	1.00-4.00	0.05-0.20
CNGA 120416T	12.90	12.70	4.76	1.60	•	•		•			1.00-5.00	0.05-0.20

ISOTURN

CNGX-Ceramic
80° Rhombic Double-Sided
Dimpled Ceramic Inserts with a
T-Land for Machining Cast Iron

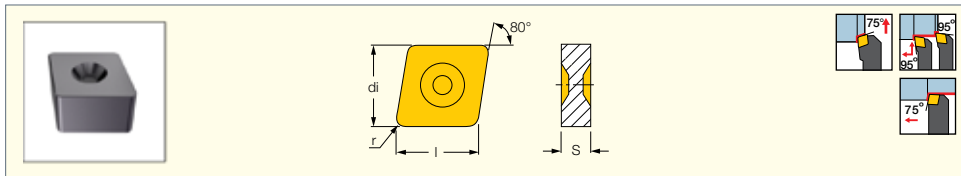

Designation	Dimensions				Tough ↔ Hard			Recommended Machining Data	
	l	di	S	r	IS8	IS80	IS6	a _p (mm)	f (mm/rev)
CNGX 120712T	12.90	12.70	7.94	1.20	●	●	●	1.00-3.00	0.07-0.43
CNGX 120716T	12.90	12.70	7.94	1.60	●	●	●	1.00-3.00	0.07-0.43

ISOTURN

SNGN-Ceramic
Square Double-Sided Ceramic Inserts
with a Flat Rake for Machining Cast
Iron, Hardened Steel and Super Alloys

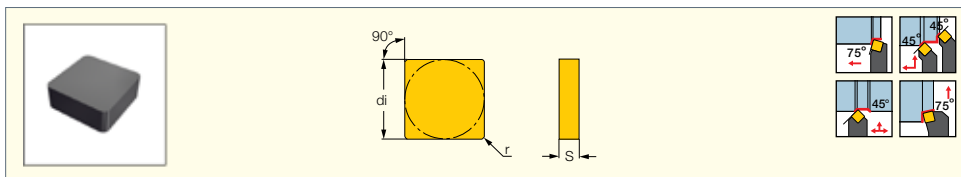

Designation	Dimensions			Tough ↔ Hard							Recommended Machining Data		
	di	S	r	IW7	IS8	IS80	IS6	IN23	IN22	IN420	IN110	a _p (mm)	f (mm/rev)
SNGN 120404T	12.70	4.76	0.40						●			0.10-3.50	0.10-0.50
SNGN 120408T	12.70	4.76	0.80	●	●			●	●	●		0.10-3.50	0.10-0.50
SNGN 120412T	12.70	4.76	1.20	●	●	●	●	●	●	●	●	0.10-5.00	0.10-0.50
SNGN 120416T	12.70	4.76	1.60	●	●	●			●	●		0.10-5.00	0.10-0.50
SNGN 120708T	12.70	7.94	0.80	●	●				●	●		0.10-5.00	0.10-0.50
SNGN 120712T	12.70	7.94	1.20	●	●	●		●			●	0.10-5.00	0.10-0.50
SNGN 120716T	12.70	7.94	1.60	●	●	●			●		●	0.10-5.00	0.10-0.50
SNGN 150712T	15.88	6.35	1.20	●								0.10-5.00	0.10-0.50
SNGN 150716T	15.88	6.35	1.60	●	●							0.10-5.00	0.10-0.50

ISOTURN

SNGA-Ceramic
Square Double-Sided Ceramic
Inserts with a Flat Rake for Machining
Cast Iron and Hardened Steel

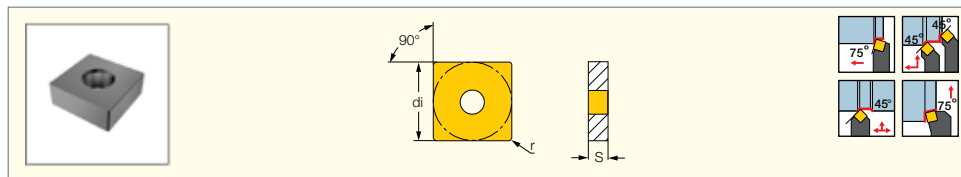

Designation	Dimensions			Tough ↔ Hard				Recommended Machining Data	
	di	S	r	IS8	IN23	IN22	IN420	a _p (mm)	f (mm/rev)
SNGA 120404T	12.70	4.76	0.40			●		0.10-3.00	0.05-0.30
SNGA 120408T	12.70	4.76	0.80	●	●	●	●	0.10-3.50	0.05-0.30
SNGA 120412T	12.70	4.76	1.20	●	●			0.10-4.00	0.05-0.30
SNGA 120416T	12.70	4.76	1.60	●				0.10-4.50	0.05-0.30

ISOTURN

SNGX-Ceramic

Square Double-Sided Dimpled Ceramic Inserts with a Flat Rake for Machining Cast Iron

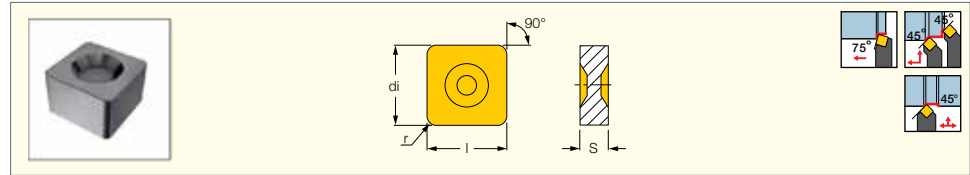

Designation	Dimensions				Tough ↔ Hard			Recommended Machining Data	
	di	S	r	l	IS8	IS80	IS6	ap (mm)	f (mm/rev)
SNGX 120712T	12.70	7.94	1.20	12.70	●	●	●	0.10-5.00	0.10-0.50
SNGX 120716T	12.70	7.94	1.60	12.70	●	●	●	0.10-5.00	0.10-0.50

ISOTURN

DNGA-Ceramic

55° Rhombic Double-Sided Ceramic Inserts for Machining Cast Iron and Hardened Steel

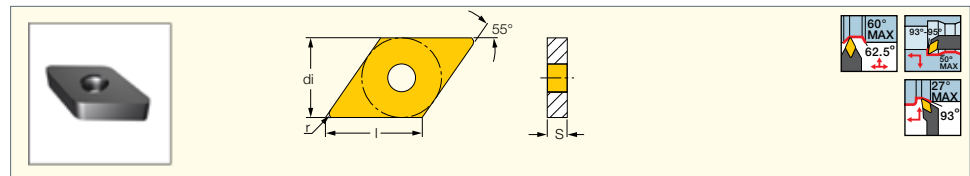

Designation	Dimensions				Tough ↔ Hard				Recommended Machining Data	
	l	di	S	r	IS8	IN23	IN22	IN420	ap (mm)	f (mm/rev)
DNGA 150404T	15.50	12.70	4.76	0.40		●	●		0.10-3.00	0.07-0.50
DNGA 150408T	15.50	12.70	4.76	0.80	●	●	●		0.10-3.50	0.07-0.50
DNGA 150412T	15.50	12.70	4.76	1.20		●			0.10-4.00	0.07-0.50
DNGA 150604T	15.50	12.70	6.35	0.40		●			0.10-3.50	0.07-0.50
DNGA 150608T	15.50	12.70	6.35	0.80		●	●		0.10-4.00	0.07-0.50
DNGA 150612T	15.50	12.70	6.35	1.20			●		0.10-5.00	0.07-0.50

ISOTURN

DNGX-Ceramic

55° Rhombic Double-Sided Dimpled Ceramic Inserts for Machining Cast Iron

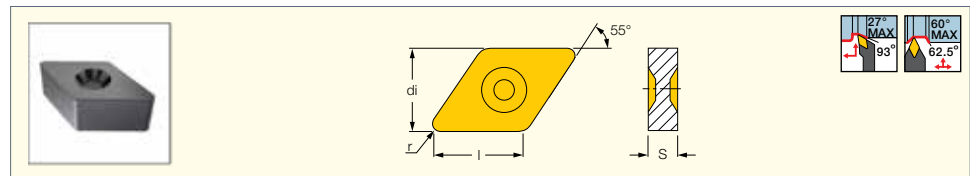

Designation	Dimensions				Tough ↔ Hard			Recommended Machining Data	
	l	di	S	r	IS8	IS80	IS6	ap (mm)	f (mm/rev)
DNGX 150712T	12.70	12.70	7.94	1.20	●	●	●	0.10-4.00	0.10-0.50
DNGX 150716T	15.50	12.70	7.94	1.60	●	●		0.10-5.00	0.10-0.50

ISOTURN

VNGA-Ceramic

35° Rhombic Double-Sided Ceramic Inserts with a T-Land for Machining Cast Iron and Hardened Steel

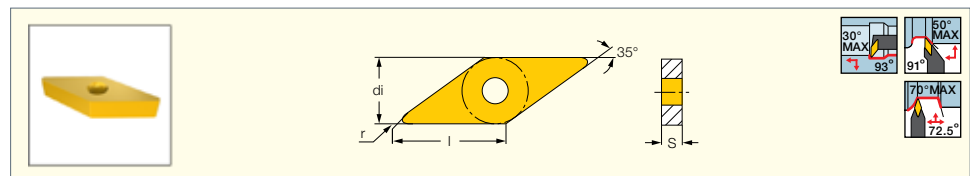

Designation	Dimensions				Tough ↔ Hard		Recommended Machining Data	
	l	di	S	r	IN22	IN420	ap (mm)	f (mm/rev)
VNGA 160404T	16.60	9.52	4.76	0.40	●	●	0.70-2.50	0.06-0.30
VNGA 160408T	16.60	9.52	4.76	0.80		●	0.80-3.00	0.08-0.35

ISOTURN

TNGN-Ceramic
 Triangular Double-Sided
 Ceramic Inserts for Machining
 Cast Iron, Hardened Steel
 and Nickel Based Alloys

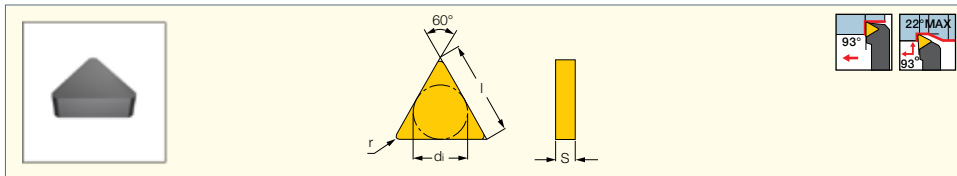

Designation	Dimensions				Tough ↔ Hard						Recommended Machining Data	
	l	di	S	r	IW7	IS8	IS80	IN23	IN22	IN420	a _p (mm)	f (mm/rev)
TNGN 160408T	16.50	9.52	4.76	0.80	•	•		•	•	•	1.00-3.50	0.10-0.35
TNGN 160412T	16.50	9.52	4.76	1.20	•	•	•				0.10-4.00	0.10-0.40
TNGN 220408T	22.00	12.70	4.76	0.80		•					0.10-5.00	0.10-0.50
TNGN 220712T	22.00	12.70	7.94	1.20	•						0.10-5.00	0.10-0.50

ISOTURN

TNGA-Ceramic
 Triangular Double-Sided Ceramic
 Inserts for Machining Super
 Alloys and Hardened Steel

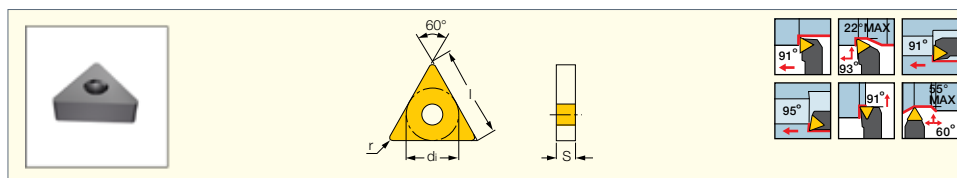

Designation	Dimensions				Tough ↔ Hard			Recommended Machining Data	
	l	di	S	r	IN23	IN22	IN420	a _p (mm)	f (mm/rev)
TNGA 160404T	16.50	9.52	4.76	0.40	•	•	•	0.10-3.00	0.07-0.50
TNGA 160408T	16.50	9.52	4.76	0.80	•	•	•	0.10-3.50	0.07-0.50
TNGA 160412T	16.50	9.52	4.76	1.20	•	•	•	0.10-4.00	0.07-0.50
TNGA 220408T	22.00	12.70	4.76	0.80	•	•	•	0.10-5.00	0.07-0.50
TNGA 220416T	22.00	12.70	4.76	1.60	•			0.10-5.00	0.07-0.50

ISOTURN

TPGN-Ceramic
 Triangular Ceramic Inserts
 with an 11° Positive Flank for
 Machining Hardened Steel

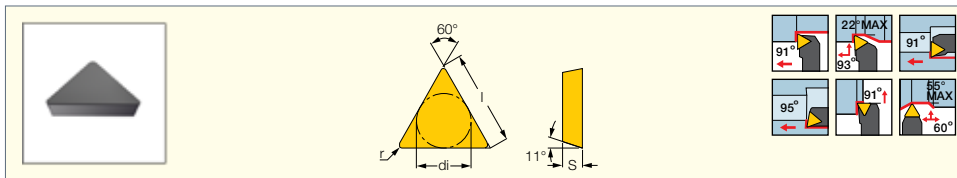

Designation	Dimensions				Tough ↔ Hard			Recommended Machining Data	
	l	di	S	r	IN23	IN22	IN420	a _p (mm)	f (mm/rev)
TPGN 090204T	9.60	5.56	2.38	0.40		•		0.10-1.50	0.07-0.30
TPGN 110304T	11.00	6.35	3.18	0.40		•	•	0.10-1.50	0.07-0.30
TPGN 110308T	11.00	6.35	3.18	0.80	•	•	•	0.10-3.00	0.07-0.40
TPGN 160304T	16.50	9.52	3.18	0.40	•	•	•	0.10-4.00	0.07-0.50
TPGN 160308T	16.50	9.52	3.18	0.80	•	•	•	0.10-4.00	0.07-0.50

ISOTURN

RNGN-Ceramic

Round Double-Sided Ceramic Inserts for Machining Cast Iron, Nickel Based Alloys and Hardened Steel

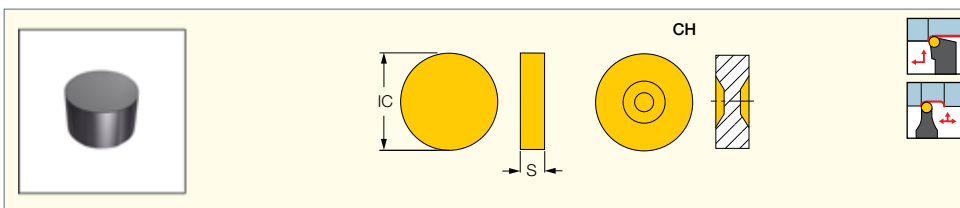

Designation	Dimensions		Tough ↔ Hard						Recommended Machining Data	
	I _C	S	IW7	IS35	IS25	IN23	IN22	IN420	a _p (mm)	f (mm/rev)
RNGN 090300T	9.52	3.18	●				●		0.10-2.00	0.07-0.20
RNGN 090400T	9.52	4.76	●				●		0.10-2.00	0.07-0.20
RNGN 120400T	12.70	4.76	●				●	●	0.10-3.50	0.07-0.50
RNGN 120700 S6 ⁽¹⁾	12.70	7.94	●						1.00-2.00	-
RNGN 120700E	12.70	7.94	●	●	●				0.10-2.00	0.07-0.20
RNGN 120700E-CH ⁽²⁾	12.70	7.94		●	●				0.10-2.00	0.07-0.20
RNGN 120700T	12.70	7.94	●	●	●	●	●	●	0.10-4.50	0.07-0.50
RNGN 120700T-CH ⁽²⁾	12.70	7.94		●	●				0.10-4.50	0.07-0.50
RNGN 120700TE	12.70	7.94		●	●				0.10-4.50	0.07-0.50
RNGN 120700T02020	12.70	7.94	●						0.10-2.00	0.07-0.20
RNGN 150700T	15.88	7.94	●						0.10-3.00	0.07-0.20
RNGN 190700T	19.05	7.94	●						0.10-3.00	0.07-0.20
RNGN 190700TE	19.05	7.94		●	●				0.10-3.00	0.07-0.20

⁽¹⁾ For milling nickel based superalloys; reference recommendations for milling Inconel 718: 0.12 mm/t 900-1000 m/min

⁽²⁾ Insert with a dimple

ISOTURN

RCGX-Ceramic

Round Ceramic Inserts for Machining Nickel Based Alloys and Hardened Steel

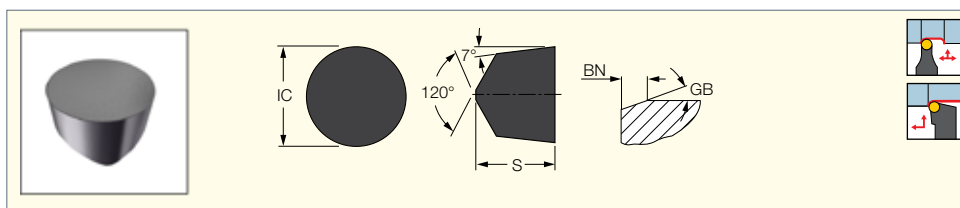

Designation	Dimensions				Tough ↔ Hard				Recommended Machining Data	
	I _C	S	G _B	B _N	IW7	IS35	IS25	IN23	a _p (mm)	f (mm/rev)
RCGX 090700E	9.52	7.94	25.0	0.20	●	●	●		0.10-3.00	0.07-0.50
RCGX 090700T	9.52	7.94	25.0	0.20	●	●	●	●	0.10-3.00	0.07-0.50
RCGX 090700TE	9.52	7.94	25.0	0.20		●	●		0.10-3.00	0.07-0.50
RCGX 120700E	12.70	7.94	25.0	0.20	●	●	●		0.10-4.00	0.07-0.50
RCGX 120700T	12.70	7.94	25.0	0.20	●			●	0.10-4.00	0.07-0.50

ISOTURN

CNMA (PCD)

80° Rhombic Inserts with a Single PCD Top Corner Tip and Positive Rake for Finishing Applications

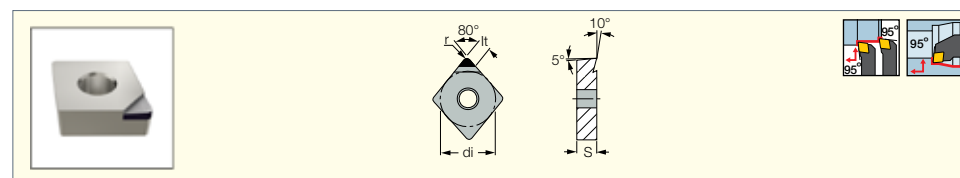

Designation	Dimensions						ID5	Recommended Machining Data	
	l	di	S	r	l ₁	a _p (mm)		f (mm/rev)	
CNMA 120404D	12.90	12.70	4.76	0.40	3.9	●	0.10-3.00	0.05-0.26	
CNMA 120408D	12.90	12.70	4.76	0.80	3.6	●	0.10-3.00	0.05-0.26	

ISOTURN

CCMT (PCD)

Inserts with a Single PCD Top Corner Tip, 7° Clearance and Positive Rake Angle for Finishing Aluminum

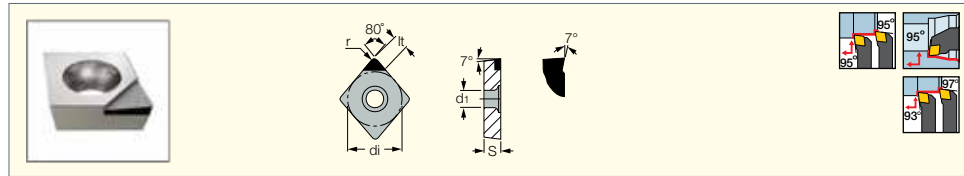

Designation	Dimensions						ID5	Recommended Machining Data	
	l	di	S	r	l ₁	d ₁		a _p (mm)	f (mm/rev)
CCMT 060202D	6.30	6.35	2.38	0.20	3.1	2.80	●	0.08-3.00	0.05-0.30
CCMT 060204D	6.30	6.35	2.38	0.40	3.0	2.80	●	0.10-3.00	0.05-0.30
CCMT 09T304D	9.70	9.52	3.97	0.40	3.9	4.40	●	0.10-3.00	0.05-0.30

ISOTURN

DCMT (PCD)

55° Rhombic Inserts with a Single PCD Top Corner Tip, 7° Clearance and Positive Rake Angle for Finishing Applications

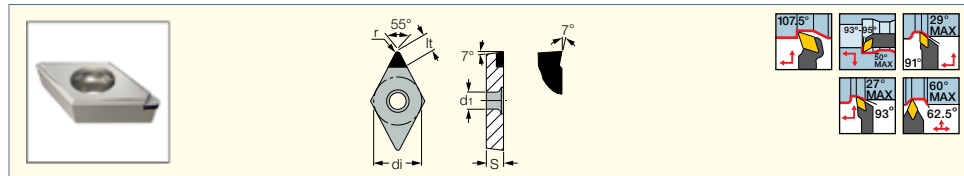

Designation	Dimensions						ID5	Recommended Machining Data	
	l	di	S	r	l ₁	d ₁		a _p (mm)	f (mm/rev)
DCMT 11T302D	11.60	9.52	3.97	0.20	3.7	4.40	●	0.10-3.00	0.05-0.30
DCMT 11T304D	11.60	9.52	3.97	0.40	3.6	4.40	●	0.10-3.00	0.05-0.30
DCMT 11T308D	11.60	9.52	3.97	0.80	3.3	4.40	●	0.10-3.00	0.05-0.29

ISOTURN

VCMT (CBN)

35° Rhombic Single Brazed Tip Corner Inserts for Finishing Aluminum (PCD) and Cast Iron (CBN)

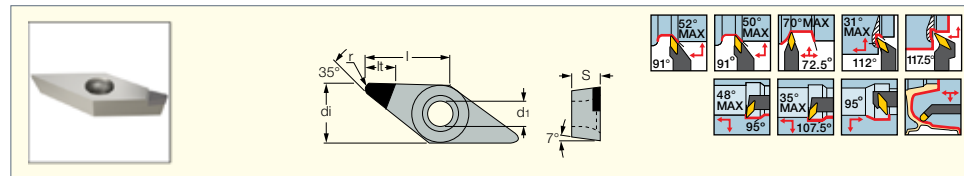

Designation	Dimensions					IB55	Recommended Machining Data	
	di	S	r	l	d ₁		a _p (mm)	f (mm/rev)
VCMT 160404T	9.52	4.76	0.40	16.60	4.40	●	0.10-3.00	0.05-0.30
VCMT 160408T	9.52	4.76	0.80	16.60	4.40	●	0.10-3.00	0.05-0.30

ISOTURN

VCGT-DW (PCD)

Inserts with 7° Clearance and a Single PCD Top Corner Tip Chipformer for Machining Aluminum

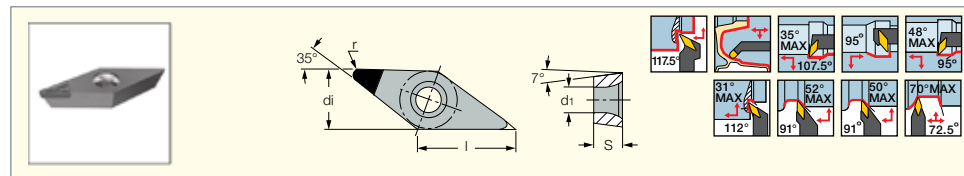

Designation	Dimensions					ID5	Recommended Machining Data	
	l	di	S	r	d ₁		a _p (mm)	f (mm/rev)
VCGT 160404-DW	16.60	9.52	4.76	0.40	4.40	●	0.10-3.00	0.05-0.30
VCGT 160408-DW	16.60	9.52	4.76	0.80	4.40	●	0.10-3.00	0.05-0.30
VCGT 160412-DW	16.60	9.52	4.76	1.20	4.40	●	0.10-3.00	0.05-0.30
VCGT 220516-DW	22.10	12.70	5.56	1.60	5.50	●	0.10-3.00	0.05-0.30
VCGT 220520-DW	22.10	12.70	5.56	2.00	5.50	●	0.10-3.00	0.05-0.30
VCGT 220530-DW	22.10	12.70	5.56	3.00	5.50	●	0.10-3.00	0.05-0.30

ISOTURN

TCMT (PCD)

Inserts with a Single PCD Top Corner Tip, 7° Clearance and Positive Rake Angle for Finishing Aluminum

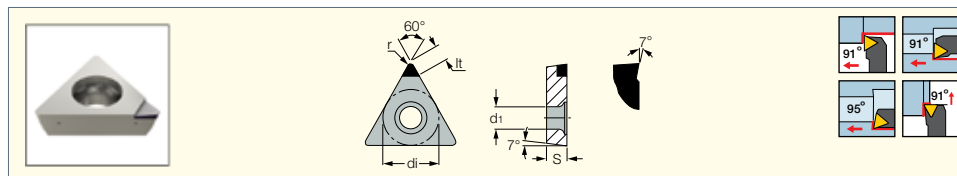

Designation	Dimensions						ID5	Recommended Machining Data	
	l	di	S	r	li	di		ap (mm)	f (mm/rev)
TCMT 110204D	11.00	6.35	2.38	0.40	3.8	2.80	●	0.10-3.00	0.05-0.30

ISOTURN

TPGX (PCD)

Triangular Inserts with a Single PCD Top Corner Tip, 11° Clearance and Positive Rake Angle for Finishing Aluminum

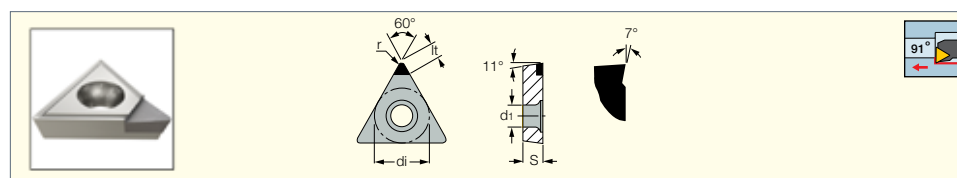

Designation	Dimensions						ID5	Recommended Machining Data	
	l	di	S	r	li	di		ap (mm)	f (mm/rev)
TPGX 090202	9.52	5.56	2.38	0.20	3.0	2.50	●	0.10-3.00	0.05-0.30
TPGX 090204	9.52	5.56	2.38	0.40	3.0	2.50	●	0.10-3.00	0.05-0.30
TPGX 110302	11.00	6.35	3.18	0.20	3.4	3.50	●	0.10-3.00	0.05-0.30
TPGX 110304	11.00	6.35	3.18	0.40	3.8	3.50	●	0.10-3.00	0.05-0.30

ISOTURN

WNGA-M3 (CBN)

Multi-Cornered CBN Inserts for Machining Hardened Steel

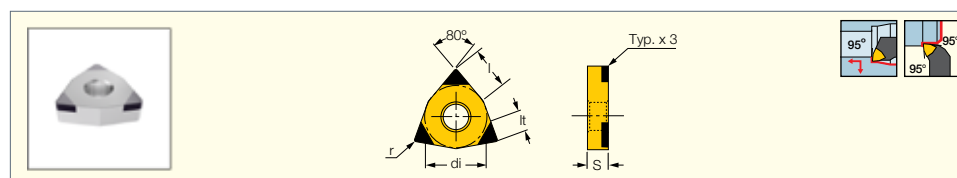

Designation	Dimensions					IB20H	Recommended Machining Data	
	l	di	S	r	li		ap (mm)	f (mm/rev)
WNGA 080408-M3	8.70	12.70	4.76	0.80	2.2	●	0.05-0.50	0.05-0.20

ISOTURN

WNGA-MC/M6 (CBN)

Multi-Cornered CBN Inserts for Machining Hardened Steel

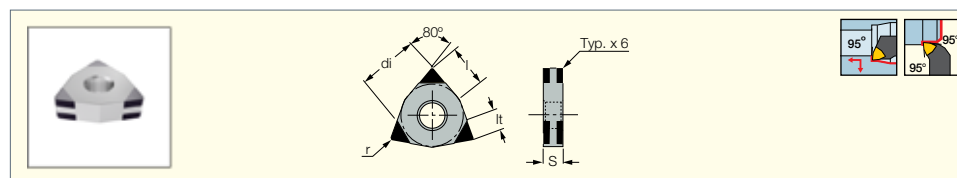

Designation	Dimensions					Tough ↔ Hard		Recommended Machining Data	
	l	di	S	r	li	IB55	IB10HC	ap (mm)	f (mm/rev)
WNGA 080404T-MC	8.70	12.70	4.76	0.40	3.1	●	●	0.05-0.50	0.05-0.20
WNGA 080408-M6	8.70	12.70	4.76	0.80	2.2	●	●	0.05-0.50	0.05-0.20
WNGA 080408T-MC	8.70	12.70	4.76	0.80	3.1	●	●	0.05-0.50	0.05-0.20
WNGA 080412T-MC	8.70	12.70	4.76	1.20	3.1	●	●	0.05-0.50	0.05-0.20

ISOTURN

CNMA-T/M1/WG (CBN)

80° Rhombic Inserts with a Single CBN Top Corner Tip for Machining Cast Iron, Hardened Steel and Super Alloys

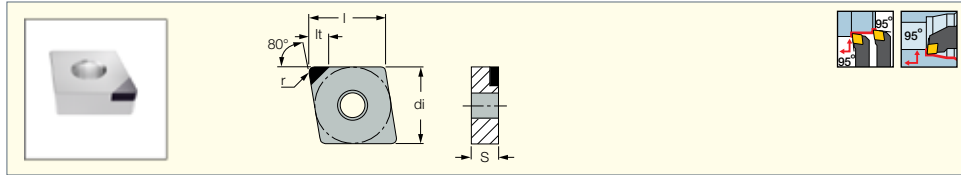

Designation	Dimensions					Tough ↔ Hard					Recommended Machining Data	
	l	di	S	r	lt	IB90	IB85	IB20H	IB55	IB50	ap (mm)	f (mm/rev)
CNMA 120404T	12.90	12.70	4.76	0.40	3.2	●			●	●	0.05-0.50	0.05-0.26
CNMA 120408-M1	12.90	12.70	4.76	0.80	3.5			●			0.05-0.50	0.05-0.30
CNMA 120408T	12.90	12.70	4.76	0.80	3.4	●	●		●		0.05-0.50	0.05-0.30
CNMA 120408T-WG ⁽¹⁾	12.90	12.70	4.76	0.80	3.5	●	●		●	●	0.05-0.50	0.05-0.30
CNMA 120412-M1	12.90	12.70	4.76	1.20	3.5			●			0.05-0.50	0.05-0.30
CNMA 120412T	12.90	12.70	4.76	1.20	4.0				●		0.05-0.50	0.05-0.30

ISOTURN

CNMA-MW2 (CBN)

80° Rhombic Inserts with 2 CBN Wiper Edge Tips for Machining Hardened Steel

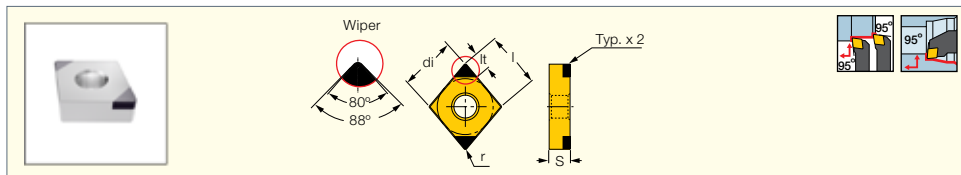

Designation	Dimensions					IB10H	Recommended Machining Data	
	L	lc	S	Re	Le		ap (mm)	f (mm/rev)
CNMA 120408-MW2	12.90	12.70	4.76	0.80	3.5	●	0.05-0.30	0.03-0.40

ISOTURN

CNMA-MW4 (CBN)

80° Rhombic Inserts with 4 CBN Wiper Edge Tips for Machining Hardened Steel

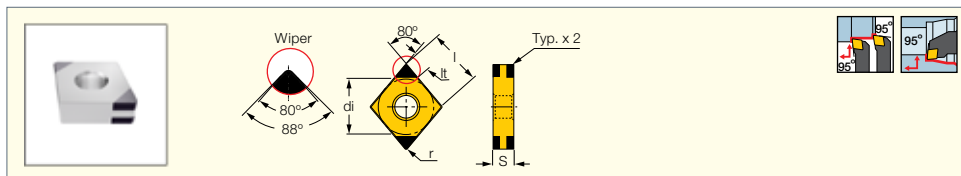

Designation	Dimensions					IB25HC	Recommended Machining Data	
	l	di	S	r	lt		ap (mm)	f (mm/rev)
CNMA 120408-MW4	12.90	12.70	4.76	0.80	2.2	●	0.05-0.50	0.05-0.40
CNMA 120412-MW4	12.90	12.70	4.76	1.20	2.4	●	0.05-0.50	0.05-0.40

ISOTURN

CNGA-4 (CBN)
4-Cornered CBN Inserts for Machining Hardened Steel

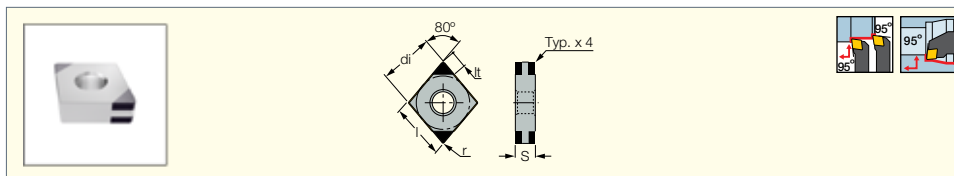

Designation	Dimensions					Tough ↔ Hard			Recommended Machining Data	
	l	di	S	r	li	IB25HC	IB55	IB10HC	ap (mm)	f (mm/rev)
CNGA 120404T-MC	12.90	12.70	4.76	0.40	3.1		●		0.05-0.50	0.05-0.20
CNGA 120408-M4	12.90	12.70	4.76	0.80	2.2	●		●	0.05-0.50	0.05-0.20
CNGA 120408T-MC	12.90	12.70	4.76	0.80	3.1		●		0.05-0.50	0.05-0.20
CNGA 120408T-WG-MC ⁽¹⁾	12.90	12.70	4.76	0.80	3.1		●		0.05-0.50	0.05-0.20
CNGA 120412-M4	12.90	12.70	4.76	1.20	2.4	●		●	0.05-0.50	0.05-0.20
CNGA 120412T-MC	12.90	12.70	4.76	1.20	3.1		●		0.05-0.50	0.05-0.20

⁽¹⁾ Wiper corner configuration

ISOTURN

CNGA-2 (CBN)
80° Rhombic Inserts with 2 CBN Tips for Machining Hardened Steel, Sintered Metals and High Temperature Alloys

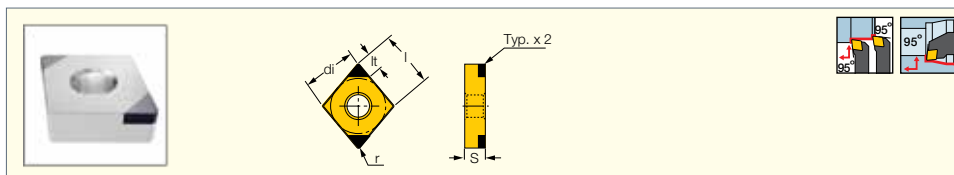

Designation	Dimensions					Tough ↔ Hard						Recommended Machining Data	
	l	di	S	r	li	IB10S	IB05S	IB20H	IB20HC	IB10H	IB10HC	ap (mm)	f (mm/rev)
CNGA 120404-F2	12.90	12.70	4.76	0.40	2.3	●	●		●		●	0.05-0.50	0.05-0.20
CNGA 120404-M2	12.90	12.70	4.76	0.40	2.3				●		●	0.05-0.30	0.05-0.20
CNGA 120404-R2	12.90	12.70	4.76	0.40	2.2			●				0.05-0.50	0.05-0.20
CNGA 120408-F2	12.90	12.70	4.76	0.80	2.2		●		●	●		0.05-0.30	0.05-0.18
CNGA 120408-M2	12.90	12.70	4.76	0.80	2.2	●		●		●		0.05-0.30	0.05-0.18
CNGA 120408-R2	12.90	12.70	4.76	0.80	2.2			●				0.05-0.50	0.05-0.20
CNGA 120408-S2	12.90	12.70	4.76	0.80	2.2		●					0.05-0.50	0.05-0.20
CNGA 120412-F2	12.90	12.70	4.76	1.20	2.4				●		●	0.05-0.50	0.05-0.20
CNGA 120412-M2	12.90	12.70	4.76	1.20	2.4	●		●		●		0.05-0.30	0.05-0.20
CNGA 120412-R2	12.90	12.70	4.76	1.20	2.4				●			0.05-0.50	0.05-0.20

ISOTURN

CNGG-M4HF/M4HM (CBN)
80° Rhombic Inserts with 4 Chipbreaking CBN Tips for Machining Hardened Steel

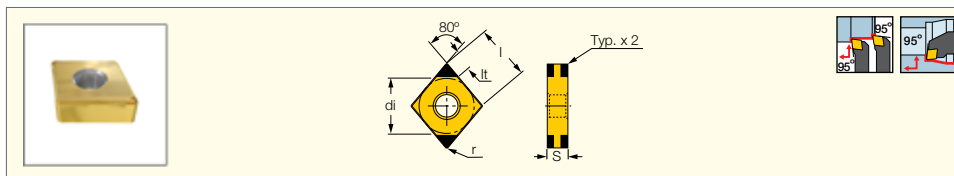

Designation	Dimensions					IB25HA	Recommended Machining Data	
	l	di	S	r	li		ap (mm)	f (mm/rev)
CNGG 120408-M4HF	12.90	12.70	4.76	0.80	2.2	●	0.20-0.75	0.05-0.20
CNGG 120412-M4HM	12.90	12.70	4.76	1.20	2.4	●	0.50-1.00	0.05-0.20

ISOTURN

CCGW/CCMT (CBN)
80° Rhombic Inserts with a Single CBN Top Corner Tip and 7° Clearance for Machining Hardened Steel

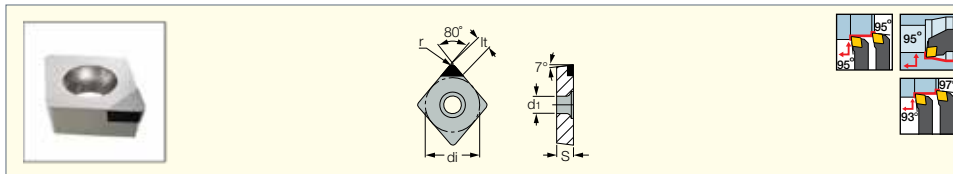

Designation	Dimensions						Tough ↔ Hard			Recommended Machining Data	
	l	di	S	r	li	dl	IB05H	IB55	IB10H	ap (mm)	f (mm/rev)
	CCGW 03X102T01015-1	3.63	3.57	1.39	0.20	2.0	1.90	•		•	0.05-0.50
CCGW 03X104T01015-1	3.63	3.57	1.39	0.40	2.3	1.90	•		•	0.05-0.50	0.05-0.20
CCGW 04T102T01015-1	4.44	4.37	1.79	0.20	2.0	2.30	•		•	0.05-0.50	0.05-0.20
CCGW 04T104T01015-1	4.44	4.37	1.79	0.40	2.3	2.30	•		•	0.05-0.50	0.05-0.20
CCMT 060202T	6.30	6.35	2.38	0.20	2.6	2.80		•		0.05-0.50	0.05-0.20
CCMT 060204T	6.30	6.35	2.38	0.40	2.7	2.80		•		0.05-0.50	0.05-0.20
CCMT 09T304T	9.70	9.52	3.97	0.40	2.9	4.40		•		0.05-0.50	0.05-0.20
CCMT 09T308T	9.70	9.52	3.97	0.80	3.6	4.40		•		0.05-0.50	0.05-0.20

ISOTURN

CCGW/CCMW-2 (CBN)
80° Positive Rhombic Inserts with 2 CBN Tips for Machining Hardened Steel, Sintered Metals and High Temperature Alloys

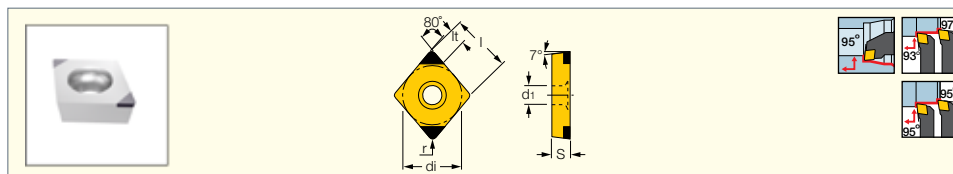

Designation	Dimensions						Tough ↔ Hard					Recommended Machining Data	
	di	l	S	r	li	dl	IB05S	IB20H	IB20HC	IB10H	IB10HC	ap (mm)	f (mm/rev)
	CCGW 060202-F2	6.35	6.30	2.38	0.20	2.3	2.80			•		•	0.05-0.50
CCGW 060204-F2	6.35	6.30	2.38	0.40	2.3	2.80			•		•	0.05-0.50	0.05-0.20
CCGW 09T304-F2	9.52	9.70	3.97	0.40	2.3	4.40			•		•	0.05-0.50	0.05-0.20
CCGW 09T308-F2	9.52	9.70	3.97	0.80	2.2	4.40			•		•	0.05-0.50	0.05-0.20
CCGW 060202-M2	6.35	6.30	2.38	0.20	2.3	2.80					•	0.05-0.50	0.05-0.20
CCGW 060204-M2	6.35	6.30	2.38	0.40	2.3	2.80	•				•	0.05-0.50	0.05-0.20
CCMW 060202-M2	6.35	6.30	2.38	0.20	2.3	2.80		•			•	0.05-0.50	0.05-0.20
CCMW 060204-M2	6.35	6.30	2.38	0.40	2.3	2.80		•			•	0.05-0.50	0.05-0.20
CCGW 09T304-M2	9.52	9.70	3.97	0.40	2.3	4.40	•				•	0.05-0.50	0.05-0.30
CCGW 09T308-M2	9.52	9.70	3.97	0.80	2.2	4.40	•				•	0.05-0.50	0.05-0.30
CCMW 09T304-M2	9.52	9.70	3.97	0.40	2.3	4.40		•			•	0.05-0.50	0.05-0.15
CCMW 09T308-M2	9.52	9.70	3.97	0.80	2.2	4.40		•			•	0.05-0.50	0.05-0.30
CCGW 060204-R2	6.35	6.30	2.38	0.40	2.3	2.80			•			0.05-0.50	0.05-0.20
CCGW 09T304-R2	9.52	9.70	3.97	0.40	2.3	4.40			•			0.05-0.50	0.05-0.20
CCGW 09T308-R2	9.52	9.70	3.97	0.80	2.2	4.40			•			0.05-0.50	0.05-0.20

ISOTURN

DNMA (CBN)
CBN Inserts with a Flat Rake for Machining Hardened Steel

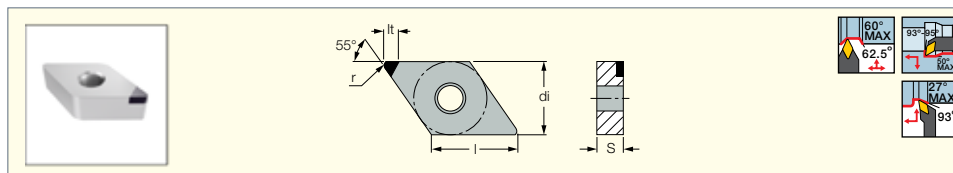

Designation	Dimensions					Tough ↔ Hard		Recommended Machining Data	
	l	di	S	r	li	IB55	IB50	ap (mm)	f (mm/rev)
	DNMA 150404T	15.50	12.70	4.76	0.40	2.8	•		0.05-0.50
DNMA 150408T	15.50	12.70	4.76	0.80	3.2	•	•	0.05-0.50	0.05-0.20
DNMA 150412T	15.50	12.70	4.76	1.20	3.0	•		0.05-0.50	0.05-0.20
DNMA 150604T	15.50	12.70	6.35	0.40	2.8	•		0.05-0.50	0.05-0.20
DNMA 150608T	15.50	12.70	6.35	0.80	3.2	•		0.05-0.50	0.05-0.20
DNMA 150612T	15.50	12.70	6.35	1.20	3.0	•	•	0.05-0.50	0.05-0.20

ISOTURN

DNGA-4 (CBN)

55° Rhombic 4-Cornered CBN Inserts for Machining Hardened Steel

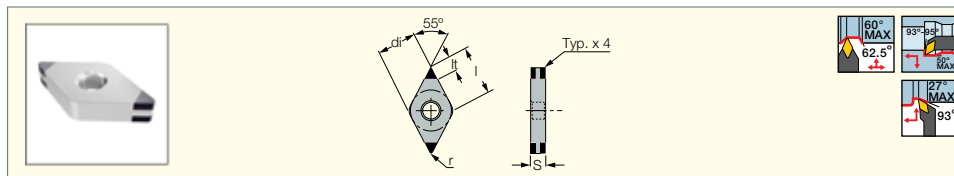

Designation	Dimensions					Tough ↔ Hard			Recommended Machining Data	
	l	di	S	r	l ₁	IB25HC	IB55	IB10HC	a _p (mm)	f (mm/rev)
DNGA 150404T-MC	15.50	12.70	4.76	0.40	2.9		●		0.05-0.50	0.05-0.18
DNGA 150408-M4	15.50	12.70	4.76	0.80	2.1	●		●	0.05-0.50	0.05-0.18
DNGA 150408T-MC	15.50	12.70	4.76	0.80	3.0		●		0.05-0.50	0.05-0.18
DNGA 150412-M4	15.50	12.70	4.76	1.20	2.0	●		●	0.05-0.50	0.05-0.18
DNGA 150412T-MC	15.50	12.70	4.76	1.20	3.0		●		0.05-0.50	0.05-0.18
DNGA 150604T-MC	15.50	12.70	6.35	0.40	2.9		●		0.05-0.50	0.05-0.18
DNGA 150608T-MC	15.50	12.70	6.35	0.80	3.0		●		0.05-0.50	0.05-0.18
DNGA 150612T-MC	15.50	12.70	6.35	1.20	3.0		●		0.05-0.50	0.05-0.18

ISOTURN

DNGA-2 (CBN)

55° Rhombic Inserts with 2 CBN Tips for Machining Hardened Steel, Sintered Metals and High Temperature Alloys

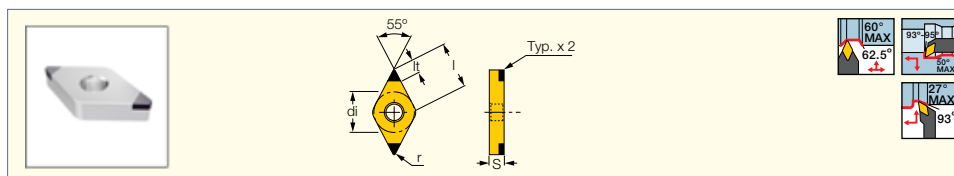

Designation	Dimensions					Tough ↔ Hard					Recommended Machining Data	
	l	di	S	r	l ₁	IB10S	IB20H	IB20HC	IB10H	IB10HC	a _p (mm)	f (mm/rev)
DNGA 150404-F2	15.50	12.70	4.76	0.40	2.5			●		●	0.10-0.50	0.05-0.30
DNGA 150404-M2	15.50	12.70	4.76	0.40	2.5	●		●		●	0.10-0.50	0.05-0.30
DNGA 150408-F2	15.50	12.70	4.76	0.80	2.1			●		●	0.10-0.50	0.05-0.30
DNGA 150408-M2	15.50	12.70	4.76	0.80	2.1	●		●		●	0.10-0.50	0.05-0.30
DNGA 150408-R2	15.50	12.70	4.76	0.80	2.1		●			●	0.05-0.50	0.05-0.20
DNGA 150412-F2	15.50	12.70	4.76	1.20	2.0			●	●		0.10-0.50	0.05-0.30
DNGA 150412-M2	15.50	12.70	4.76	1.20	2.0	●		●		●	0.10-0.50	0.05-0.30
DNGA 150412-R2	15.50	12.70	4.76	1.20	2.0		●				0.05-0.50	0.05-0.20

ISOTURN

DNGG-M4HF/M4HM (CBN)

55° Rhombic Inserts with 4 Chipbreaking CBN Tips for Machining Hardened Steel

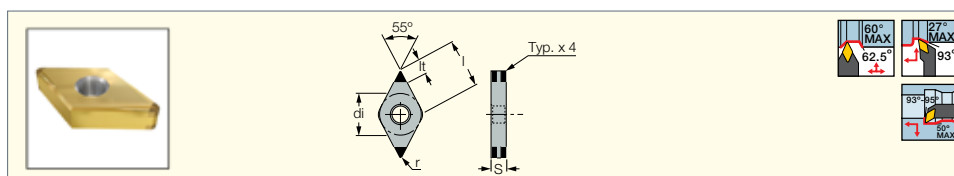

Designation	Dimensions					IB25HA	Recommended Machining Data	
	l	di	S	r	l ₁		a _p (mm)	f (mm/rev)
DNGG 150408-M4HF	15.50	12.70	4.76	0.80	2.1	●	0.20-0.75	0.05-0.20
DNGG 150412-M4HM	15.50	12.70	4.76	1.20	2.0	●	0.50-1.00	0.05-0.20

ISOTURN

DCMT (CBN)

55° Rhombic Inserts with a Single CBN Top Corner Tip and 7° Clearance for Machining Hardened Steel

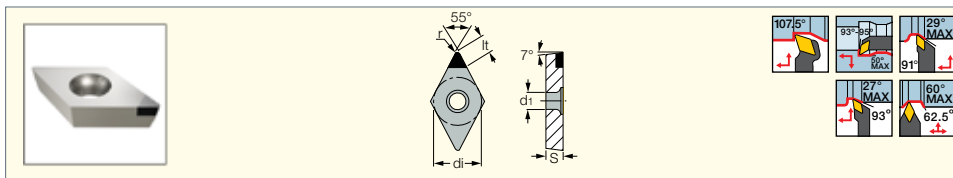

Designation	Dimensions						IB55	Recommended Machining Data	
	l	di	S	r	li	di		ap (mm)	f (mm/rev)
DCMT 11T304T	11.60	9.52	3.97	0.40	3.4	4.40	•	0.05-0.50	0.05-0.20
DCMT 11T308T	11.60	9.52	3.97	0.80	3.1	4.40	•	0.05-0.50	0.05-0.20

ISOTURN

DCGW/DCMW-2 (CBN)

55° Positive Rhombic Inserts with 2 CBN Tips for Machining Hardened Steel, Sintered Metals and High Temperature Alloys

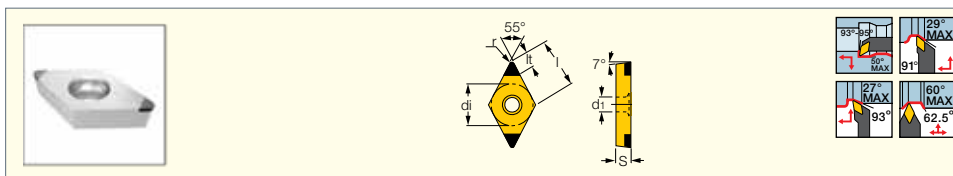

Designation	Dimensions						Tough ↔ Hard					Recommended Machining Data	
	l	di	S	r	li	di	IB05S	IB20H	IB20HC	IB10H	IB10HC	ap (mm)	f (mm/rev)
DCGW 070202-F2	7.70	6.35	2.38	0.20	2.5	2.80			•		•	0.05-0.50	0.05-0.30
DCGW 070204-F2	7.70	6.35	2.38	0.40	2.5	2.80			•		•	0.05-0.50	0.05-0.30
DCGW 11T302-F2	11.60	9.52	3.97	0.20	2.5	4.40			•		•	0.05-0.50	0.05-0.30
DCGW 11T304-F2	11.60	9.52	3.97	0.40	2.5	4.40			•		•	0.05-0.50	0.05-0.30
DCGW 11T308-F2	11.60	9.52	3.97	0.80	2.1	4.40			•		•	0.05-0.50	0.05-0.30
DCGW 070202-M2	7.70	6.35	2.38	0.20	2.5	2.80			•		•	0.05-0.50	0.05-0.30
DCGW 070204-M2	7.70	6.35	2.38	0.40	2.5	2.80	•		•		•	0.05-0.50	0.05-0.30
DCGW 070208-M2	7.70	6.35	2.38	0.80	2.5	2.80	•		•		•	0.05-0.50	0.05-0.30
DCGW 11T302-M2	11.60	9.52	3.97	0.20	2.1	4.40			•		•	0.05-0.50	0.05-0.30
DCMW 11T304-M2	11.60	9.52	3.97	0.40	2.5	4.40		•		•	•	0.05-0.50	0.05-0.12
DCGW 11T308-M2	11.60	9.52	3.97	0.80	2.1	4.40	•		•		•	0.05-0.50	0.05-0.30
DCMW 11T308-M2	11.60	9.52	3.97	0.80	2.1	4.40		•		•	•	0.05-0.50	0.05-0.15
DCGW 11T304T01315	11.60	9.52	3.97	0.40	2.5	4.40	•					0.05-0.50	0.05-0.30
DCGW 11T304-S2	11.60	9.52	3.97	0.40	2.5	4.40	•					0.05-0.50	0.05-0.30

ISOTURN

VNGA-2 (CBN)

35° Rhombic Inserts with 2 CBN Tips for Machining Hardened Steel, Sintered Metals and High Temperature Alloys

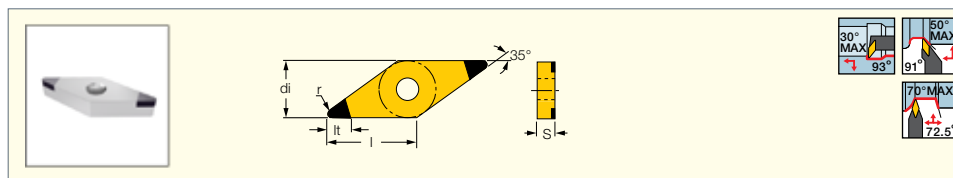

Designation	Dimensions						Tough ↔ Hard					Recommended Machining Data	
	l	di	S	r	li	di	IB10S	IB20H	IB20HC	IB10H	IB10HC	ap (mm)	f (mm/rev)
VNGA 160404-F2	16.60	9.52	4.76	0.40	3.1				•		•	0.05-0.50	0.05-0.30
VNGA 160404-M2	16.60	9.52	4.76	0.40	3.1	•		•		•	•	0.05-0.50	0.05-0.30
VNGA 160408-F2	16.60	9.52	4.76	0.80	2.2			•		•	•	0.05-0.50	0.05-0.30
VNGA 160408-M2	16.60	9.52	4.76	0.80	2.2	•		•	•		•	0.05-0.50	0.05-0.30
VNGA 160408-R2	16.60	9.52	4.76	0.80	2.2		•					0.05-0.50	0.05-0.30

ISOTURN

VNGA-4 (CBN)

35° Rhombic Inserts with 4 CBN Tips for Machining Hardened Steel

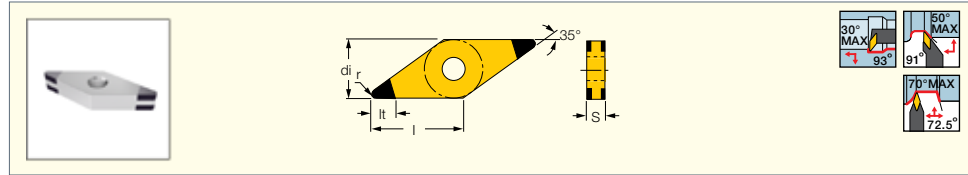

Designation	Dimensions					Tough ↔ Hard		Recommended Machining Data	
	l	di	S	r	li	IB25HC	IB10HC	ap (mm)	f (mm/rev)
VNGA 160408-M4	16.60	9.52	4.76	0.80	2.2	●	●	0.05-0.30	0.02-0.30

ISOTURN

VNGG-M4HM (CBN)

35° Rhombic Insert with 4 Chipbreaking CBN Tips for Machining Hardened Steel

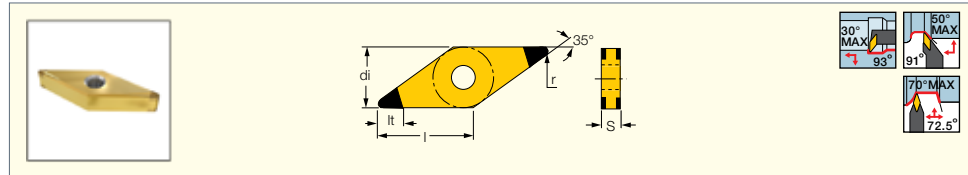

Designation	Dimensions					IB25HA	Recommended Machining Data	
	l	di	S	r	li		ap (mm)	f (mm/rev)
VNGG 160408-M4HM	16.60	9.52	4.76	0.80	2.2	●	0.50-0.80	0.05-0.20

ISOTURN

VBMT (CBN)

Single Corner CBN Tipped Inserts with a Flat Rake for Machining Hardened Steel

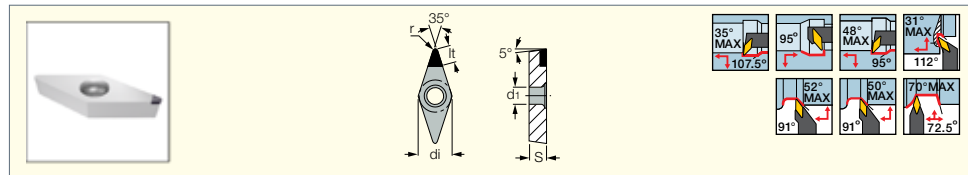

Designation	Dimensions						Tough ↔ Hard		Recommended Machining Data	
	l	di	S	r	li	di	IB55	IB50	ap (mm)	f (mm/rev)
VBMT 160404T	16.60	9.52	4.76	0.40	4.5	4.40	●	●	0.05-0.39	0.05-0.11

ISOTURN

VBGW/VBMW-2 (CBN)

35° Positive Rhombic Inserts with 2 CBN Tips for Machining Hardened Steel

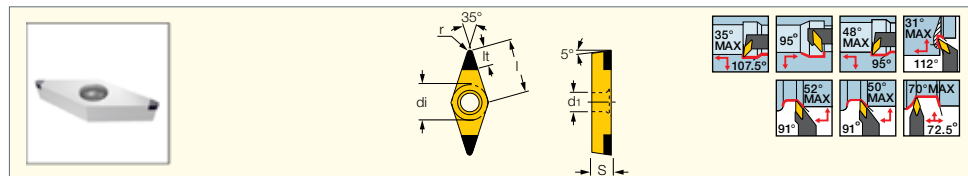

Designation	Dimensions						Tough ↔ Hard				Recommended Machining Data	
	l	di	S	r	li	di	IB20H	IB20HC	IB10H	IB10HC	ap (mm)	f (mm/rev)
VBGW 110304-F2	11.10	6.35	3.18	0.40	3.1	2.80		●		●	0.10-0.50	0.05-0.20
VBGW 160404-F2	16.60	9.52	4.76	0.40	3.1	4.40		●		●	0.10-0.50	0.05-0.20
VBGW 160408-F2	16.60	9.52	4.76	0.80	2.2	4.40		●		●	0.10-0.50	0.05-0.20
VBMW 110304-M2	11.10	6.35	3.18	0.40	3.1	2.80	●		●		0.05-0.50	0.05-0.20
VBGW 160404-M2	16.60	9.52	4.76	0.40	3.1	4.40				●	0.05-0.50	0.05-0.20
VBMW 160404-M2	16.60	9.52	4.76	0.40	3.1	4.40	●		●		0.05-0.50	0.05-0.20
VBGW 160408-M2	16.60	9.52	4.76	0.80	2.2	4.40				●	0.05-0.50	0.05-0.20
VBMW 160408-M2	16.60	9.52	4.76	0.80	2.2	4.40	●		●		0.05-0.39	0.05-0.11

ISOTURN

TNMA (CBN)

Triangular Inserts with a Single Corner CBN Tip for Machining Cast Iron and Hardened Steel

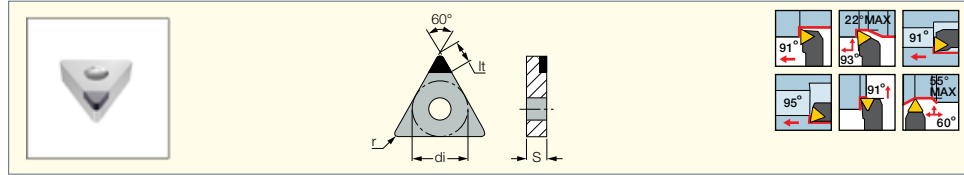

Designation	Dimensions					Tough ↔ Hard				Recommended Machining Data	
	l	di	S	r	lt	IB90	IB85	IB55	IB50	ap (mm)	f (mm/rev)
TNMA 160404T	16.50	9.52	4.76	0.40	3.9	•	•	•	•	0.05-0.50	0.05-0.25
TNMA 160408T	16.50	9.52	4.76	0.80	3.5	•	•	•	•	0.05-0.50	0.05-0.25

ISOTURN

TNGA-MC/M6 (CBN)

Triangular Multi-Cornered CBN Inserts for Machining Hardened Steel

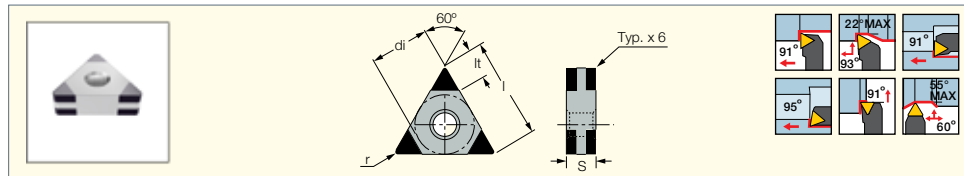

Designation	Dimensions					Tough ↔ Hard			Recommended Machining Data	
	l	di	S	r	lt	IB25HC	IB55	IB10HC	ap (mm)	f (mm/rev)
TNGA 160404T-MC	16.50	9.52	4.76	0.40	3.2	•	•	•	0.05-0.50	0.05-0.20
TNGA 160408-M6	16.50	9.52	4.76	0.80	1.9	•	•	•	0.05-0.50	0.05-0.20
TNGA 160408T-MC	16.50	9.52	4.76	0.80	1.9	•	•	•	0.05-0.50	0.05-0.20

ISOTURN

TNGA-M3 (CBN)

Triangular Inserts with 3 CBN Tips for Machining Hardened Steel, Sintered Metals and High Temperature Alloys

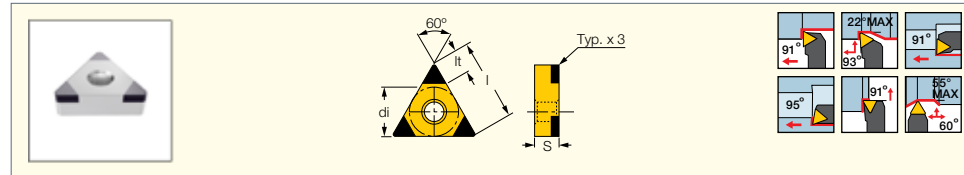

Designation	Dimensions					Tough ↔ Hard		Recommended Machining Data	
	l	di	S	r	lt	IB10S	IB20H	ap (mm)	f (mm/rev)
TNGA 160404-M3	16.50	9.52	4.76	0.40	2.2	•	•	0.10-0.50	0.05-0.30
TNGA 160408-M3	16.50	9.52	4.76	0.80	1.9	•	•	0.05-0.50	0.05-0.30
TNGA 160412-M3	16.50	9.52	4.76	1.20	2.4	•	•	0.10-0.50	0.05-0.30

ISOTURN

TCMT (CBN)

Triangular Positive Inserts with a Single CBN Flat Rake Tip for Machining Hardened Steel

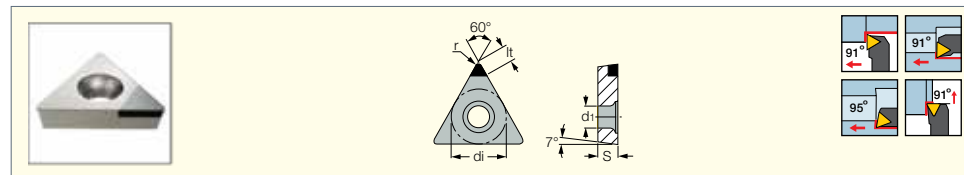

Designation	Dimensions						Tough ↔ Hard		Recommended Machining Data	
	l	di	S	r	lt	dt	IB55	IB50	ap (mm)	f (mm/rev)
TCMT 110204T	11.00	6.35	2.38	0.40	3.5	2.85	•	•	0.05-0.50	0.05-0.13

ISOTURN

TPGX (CBN)

Triangular Inserts with a Single CBN Top Corner Tip, 11° Clearance for Machining Cast Iron and Hardened Steel

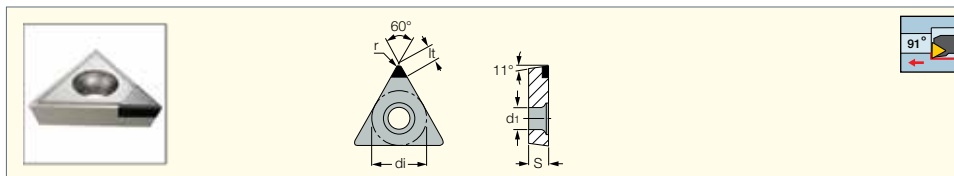

Designation	Dimensions						Tough ↔ Hard		Recommended Machining Data	
	l	di	S	r	l ₁	d ₁	IB90	IB50	a _p (mm)	f (mm/rev)
TPGX 090202T	9.52	5.56	2.38	0.20	2.5	2.50	●	●	0.05-0.05	0.03-0.20
TPGX 090204T	9.52	5.56	2.38	0.40	2.6	2.50	●	●	0.05-0.05	0.03-0.20
TPGX 110302T	11.00	6.35	3.18	0.20	3.3	3.50	●	●	0.05-0.05	0.03-0.20
TPGX 110304T	11.00	6.35	3.18	0.40	3.0	3.50	●	●	0.05-0.05	0.03-0.20

ISOTURN

TPGW-M3 (CBN)

Triangular Positive Inserts with 3 CBN Tips for Machining Sintered Metals and High Temperature Alloys

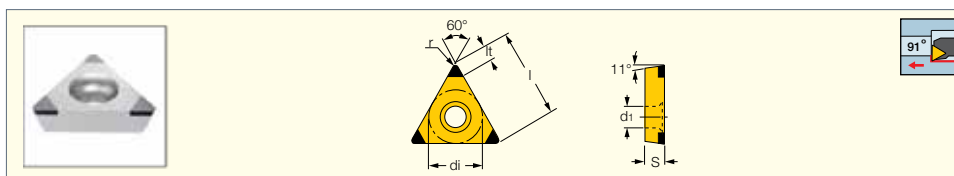

Designation	Dimensions						IB05S	Recommended Machining Data	
	l	di	S	r	l ₁	d ₁		a _p (mm)	f (mm/rev)
TPGW 110204-M3	11.00	6.35	2.38	0.40	2.2	2.80	●	0.05-0.50	0.05-0.30
TPGW 110208-M3	11.00	6.35	2.38	0.80	2.2	2.80	●	0.05-0.50	0.05-0.30
TPGW 110304-M3	11.00	6.35	3.18	0.40	2.2	3.40	●	0.05-0.50	0.05-0.30
TPGW 110308-M3	11.00	6.35	3.18	0.80	2.1	3.40	●	0.05-0.50	0.05-0.30

ISOTURN

SNMA (CBN)

Square CBN Tipped Inserts with a Single Flat Rake for Machining Cast Iron and Hardened Steel

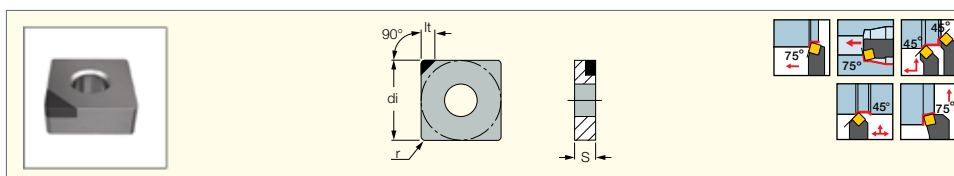

Designation	Dimensions				IB55	Recommended Machining Data	
	di	S	r	l ₁		a _p (mm)	f (mm/rev)
SNMA 120408T	12.70	4.76	0.80	4.5	●	0.05-0.50	0.05-0.30

ISOTURN

RCGX (CBN)

CBN Round Inserts with a Flat Rake for Machining Cast Iron and Hardened Steel

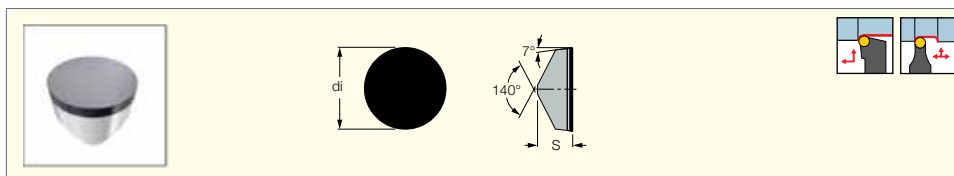

Designation	Dimensions		IB90	Recommended Machining Data	
	di	S		a _p (mm)	f (mm/rev)
RCGX 060300T	6.35	3.18	●	0.05-0.50	0.05-0.25
RCGX 090300T	9.52	3.18	●	0.05-0.50	0.05-0.25
RCGX 120400T	12.70	4.76	●	0.05-0.50	0.05-0.25

ISOTURN

CNGA-J(CBN)

Multi-cornered CBN Inserts for Machining Hardened Steel

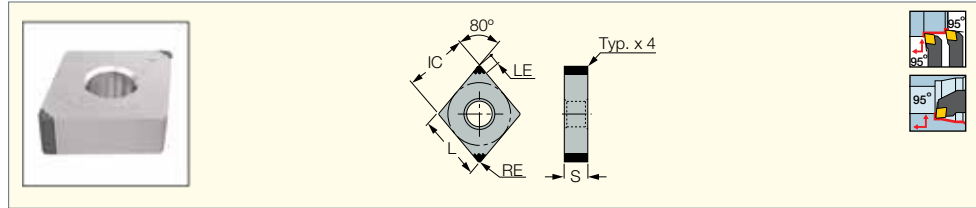

Designation	Dimensions					Recommended Machining Data	
	L	IC	S	RE	LE	a_p (mm)	f (mm/rev)
CNGA 120408-M4-J	12.90	12.70	4.76	0.80	1.50	0.12-0.80	0.10-0.30
CNGA 120408-R4-J	12.90	12.70	4.76	0.80	1.50	0.12-0.80	0.10-0.30

ISOTURN

CNGG-J(CBN)

80° Rhombic Inserts with 4 Chipbreaking CBN Tips for Machining Hardened Steel

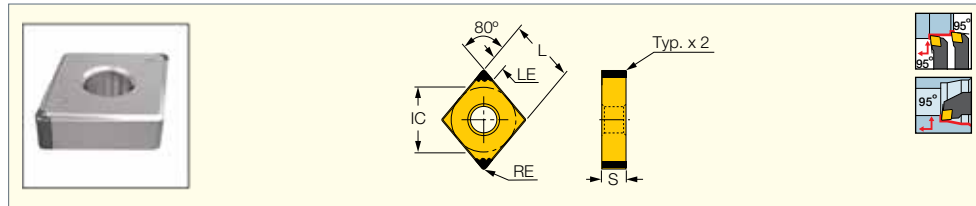

Designation	Dimensions					Recommended Machining Data	
	L	IC	S	RE	LE	a_p (mm)	f (mm/rev)
CNGG 120408-M4HM-J	12.90	12.70	4.76	0.80	1.50	0.12-0.80	0.10-0.30

ISOTURN

DNGA-J(CBN)

55° Rhombic Multi-cornered CBN Inserts for Machining Hardened Steel

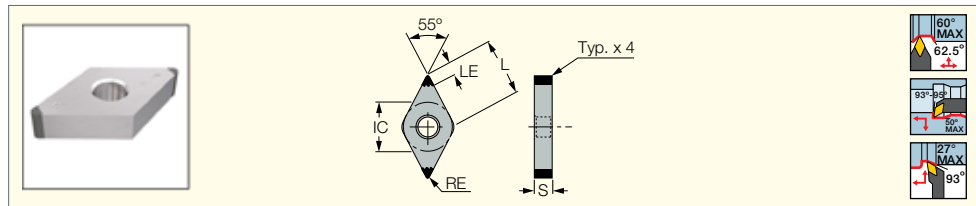

Designation	Dimensions				Recommended Machining Data	
	L	IC	RE	LE	a_p (mm)	f (mm/rev)
DNGA 150408-R4-J	15.50	12.70	0.80	1.60	0.12-0.80	0.10-0.30

ISOTURN

TNGA-J(CBN)

Triangular Multi-Cornered CBN Inserts for Machining Hardened Steel

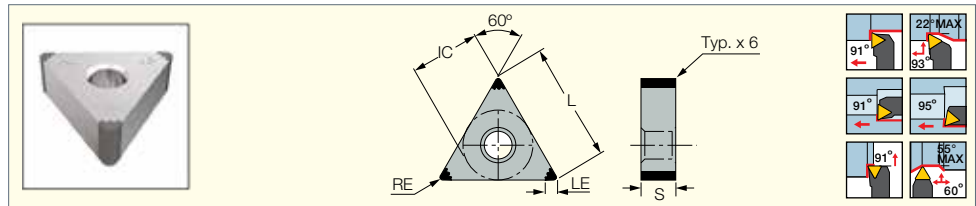

Designation	Dimensions				Recommended Machining Data	
	L	IC	RE	LE	a_p (mm)	f (mm/rev)
TNGA 160408-R6-J	16.50	9.53	0.80	1.60	0.12-0.80	0.10-0.30

ISOTURN

VNGA-J(CBN)

35° Rhombic Inserts with 4 CBN Tips for Machining Hardened Steel

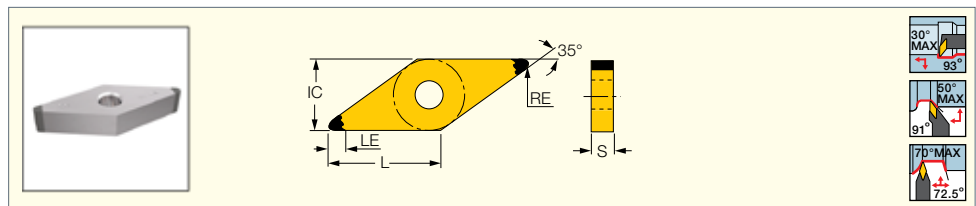

Designation	Dimensions					Recommended Machining Data	
	L	IC	S	RE	LE	a_p (mm)	f (mm/rev)
VNGA 160408-R4-J	16.60	9.53	4.76	0.80	1.70	0.12-0.80	0.10-0.30

CUTGRIP

GITM
CBN Tipped Inserts for Turning and Grooving on Hard Ferrous Materials

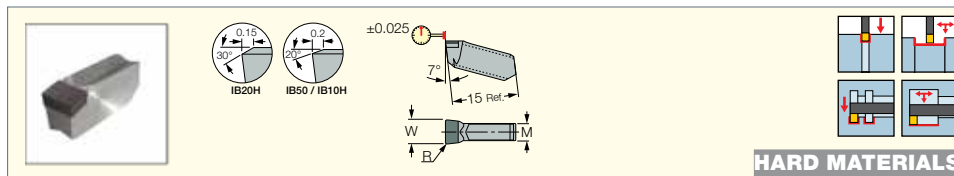

HARD MATERIALS

Designation	Dimensions				Tough ↔ Hard			Recommended Machining Data		
	W ± 0.02	R ± 0.05	R ± 0.05	M	IB20H	IB50	IB10H	a _p (mm)	f turn (mm/rev)	f groove (mm/rev)
GITM 3.00K-0.20	3.00	0.20	0.050	2.40	●	●	●	0.00-0.30	0.02-0.07	0.02-0.05
GITM 4.00K-0.20	4.00	0.20	0.050	3.20	●	●	●	0.00-0.40	0.03-0.09	0.02-0.07
GITM 5.00K-0.40	5.00	0.40	0.050	4.00	●	●	●	0.00-0.50	0.05-0.13	0.03-0.10
GITM 6.00K-0.40	6.00	0.40	0.050	4.95	●	●	●	0.00-0.60	0.05-0.15	0.04-0.12
GITM 8.00K-0.40	8.00	0.40	0.050	6.00	●	●	●	0.00-0.80	0.07-0.20	0.05-0.16

• Dmin for internal machining = 70 mm

CUTGRIP

GITM (full radius)
Full Radius CBN Tipped Inserts for Grooving and Turning on Hard Ferrous Materials

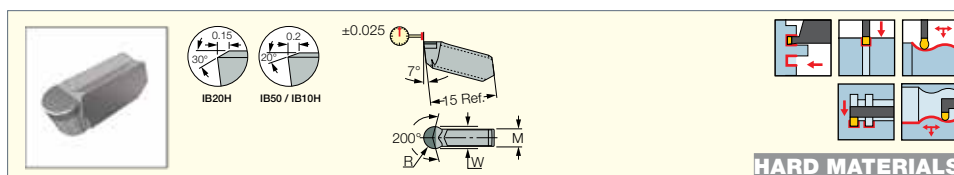

HARD MATERIALS

Designation	Dimensions				Tough ↔ Hard			Recommended Machining Data		
	W ± 0.02	R ± 0.05	M	D _{min}	IB20H	IB50	IB10H	a _p (mm)	f turn (mm/rev)	f groove (mm/rev)
GITM 3.00K-1.50	3.00	1.50	2.40	160.0	●	●	●	0.00-0.30	0.03-0.10	0.02-0.06
GITM 4.00K-2.00	4.00	2.00	3.20	160.0	●	●	●	0.00-0.40	0.04-0.14	0.02-0.09
GITM 5.00K-2.50	5.00	2.50	3.90	160.0	●	●	●	0.00-0.50	0.05-0.18	0.03-0.11
GITM 6.00K-3.00	6.00	3.00	5.00	160.0	●	●	●	0.00-0.60	0.06-0.22	0.04-0.13
GITM 8.00K-4.00	8.00	4.00	5.60	160.0	●	●	●	0.00-0.80	0.08-0.29	0.05-0.17

• Dmin for internal machining = 70 mm

CUTGRIP

GIPA (PCD)

Double-Ended Precision Ground Inserts with a Polished Top Rake for Machining Aluminum

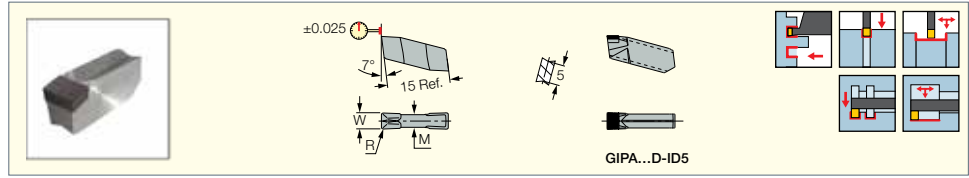

Designation	Dimensions				ID5	Recommended Machining Data		
	W±0.02	R±0.03	M	a _p (mm)		f turn (mm/rev)	f groove (mm/rev)	
GIPA 3.00-0.20-D ⁽¹⁾	3.00	0.20	2.40	●	0.25-1.80	0.12-0.25	0.09-0.16	

• Dmin for internal machining = 70 mm

⁽¹⁾ Single-ended PCD tipped insert

CUTGRIP

GIPA (full radius PCD)

Precision Double-Ended Inserts with Polished Top Rake for Machining Aluminum

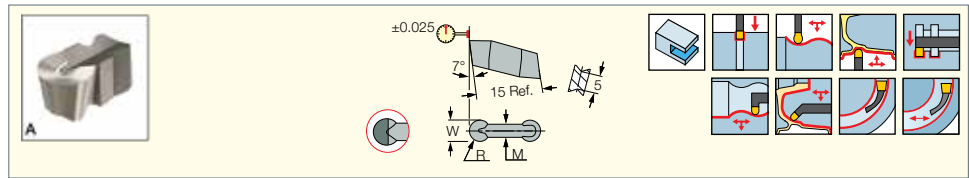

Designation	Dimensions				ID5	Recommended Machining Data		
	W±0.02	R±0.05	M	a _p (mm)		f turn (mm/rev)	f groove (mm/rev)	
GIPA 3.00-1.50-D ⁽¹⁾	3.00	1.50	2.40	●	0.00-1.50	0.19-0.36	0.09-0.19	
GIPA 3.00-1.50YZ-D ⁽²⁾	3.00	1.50	2.40	●	0.00-1.50	0.19-0.36	0.09-0.19	
GIPA 4.00-2.00-D ⁽¹⁾	4.00	2.00	3.20	●	0.00-2.00	0.25-0.53	0.12-0.26	
GIPA 4.00-2.00YZ-D ⁽²⁾	4.00	2.00	3.20	●	0.00-2.00	0.25-0.53	0.12-0.26	
GIPA 5.00-2.50-D ⁽¹⁾	5.00	2.50	3.90	●	0.00-2.50	0.22-0.60	0.11-0.30	
GIPA 5.00-2.50YZ-D ⁽²⁾	5.00	2.50	3.90	●	0.00-2.50	0.22-0.60	0.11-0.30	
GIPA 6.00-3.00-D ⁽¹⁾	6.00	3.00	4.80	●	0.00-3.00	0.26-0.72	0.13-0.36	
GIPA 6.00-3.00YZ-D ⁽²⁾	6.00	3.00	4.80	●	0.00-3.00	0.26-0.72	0.13-0.36	
GIPA 6.00-3.00CB ⁽³⁾	6.00	3.00	4.80	●	0.00-3.00	0.21-0.58	0.11-0.29	

⁽¹⁾ Single-ended PCD tipped insert

⁽²⁾ Single-ended molded PCD chipformer tipped insert

⁽³⁾ Single-ended flat PCD tipped insert with chip deflector

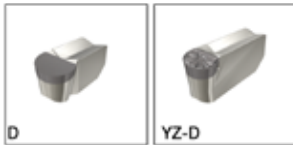

CUTGRIP

GIPA/GIDA 8 (full radius PCD)
Precision Double-Ended Inserts
with Polished Top Rake for
Machining Aluminum

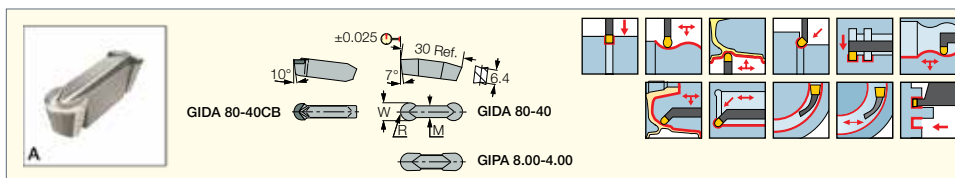

Designation	Dimensions				ID5	Recommended Machining Data		
	W ± 0.02	R ± 0.05	M			a _p (mm)	f turn (mm/rev)	f groove (mm/rev)
GIDA 80-40-D	8.00	4.00	5.60		●	0.00-4.00	0.24-0.67	0.14-0.38
GIDA 80-40CB-D ⁽¹⁾	8.00	4.00	5.60		●	0.00-4.00	0.24-0.67	0.14-0.38
GIDA 80-40YZ-D	8.00	4.00	5.60		●	0.00-4.00	0.35-0.96	0.18-0.48

- ID5 is a single-ended PCD tipped insert
- ⁽¹⁾ Should not be clamped on tools with "A" suffix



PICCO CUT

PICCO R 050 (CBN)
CBN Tipped Inserts for
Internal Turning, Profiling and
Chamfering of Hard Steel

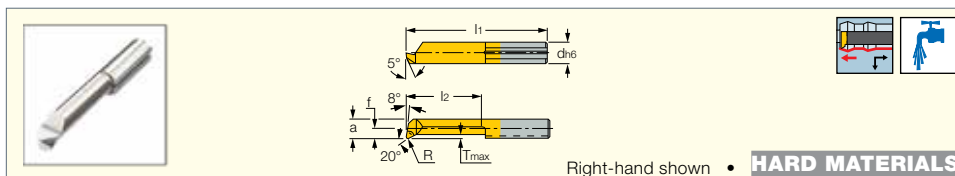

Right-hand shown • **HARD MATERIALS**

Designation	Dimensions								IB55
	d	f	a	l ₁	l ₂	T _{max}	D _{min}	R ± 0.05	
PICCO R 050.3-10B	4.00	0.60	2.60	25.50	10.0	0.20	2.80	0.10	●
PICCO R 050.4-10B	4.00	1.50	3.50	25.50	10.0	0.30	4.00	0.10	●
PICCO R 050.5-15B	5.00	1.90	4.40	31.50	15.0	0.50	5.00	0.15	●
PICCO R 050.6-15B	6.00	2.30	5.30	31.50	15.0	0.50	6.00	0.15	●
PICCO R 050.7-20B	7.00	2.80	6.30	36.50	20.0	0.60	6.80	0.15	●

- It is not recommended to use coolant when machining with CBN tipped tools
- Available on request only

CUTGRIP

GIPA 8-35V (V-shape)
V-Shaped Inserts for Machining
Aluminum Wheels

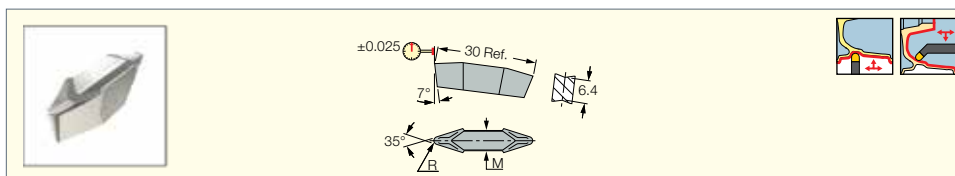

Designation	Dimensions				ID5	Recommended Machining Data	
	R	R _{toler}	M			a _p (mm)	f turn (mm/rev)
GIPA 8YZ-35V-1.20-D ⁽¹⁾	1.20	0.050	6.00		●	1.45-4.80	0.35-0.88
GIPA 8-35V-1.20-D ⁽¹⁾	1.20	0.050	6.00		●	1.45-4.80	0.35-0.88

- Precision ground and polished rake to avoid built-up edge
- Toolholder seat needs to be modified according to insert profile to ensure clearance
- ⁽¹⁾ Single-ended PCD tipped insert

ISOTURN

CCLNR/L

Clamp Lock Tools Carrying the Ceramic Negative 80° Rhombic Inserts

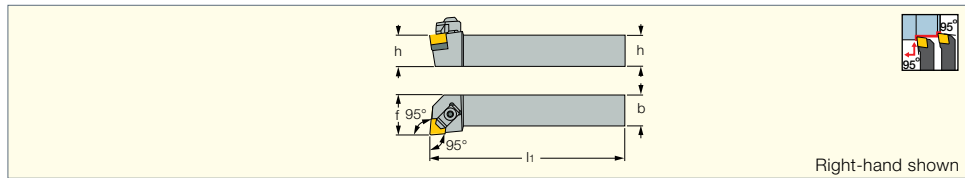

Right-hand shown

Designation	h	h ₁	b	l ₁	f	G _a °	G _r °	Insert					
CCLNR 2020K-12CEA	20.0	20.0	20.0	125.00	25.00	-4	-6	CNGN 1204	S 48	HW 4.0	BCL 6 CLAMP	SR M6X1X25ISO7380	SR M5X0.8X10
CCLNR/L 2525M-12CEA	25.0	25.0	25.0	150.00	32.00	-4	-6	CNGN 1204	S 48	HW 4.0	BCL 6 CLAMP	SR M6X1X25ISO7380	SR M5X0.8X10

ISOTURN

TCLNR/L-CH

95° Lead Angle Tools Carrying the Negative CNGX 80° Rhombic Ceramic Dimpled Inserts

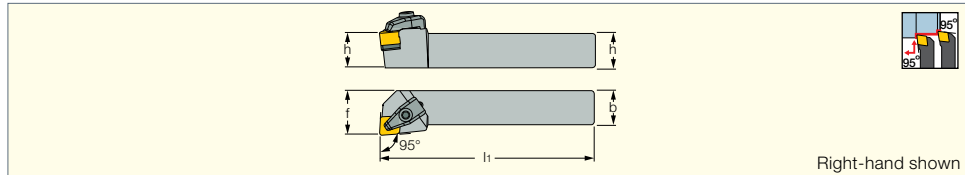

Right-hand shown

Designation	h	h ₁	b	l ₁	f	Insert						
TCLNR/L 2525M-12CH	25.0	25.0	25.0	150.00	32.00	CNGX 1207...T	S 48	SR M5X0.8X10	CCL 4	KSP 5	CSC 4	HW 4.0

ISOTURN

TCBNR/L-CH

75° Lead Angle Toolholders Using the 100° Corner of CNGX 80° Negative Rhombic Ceramic Dimpled Inserts

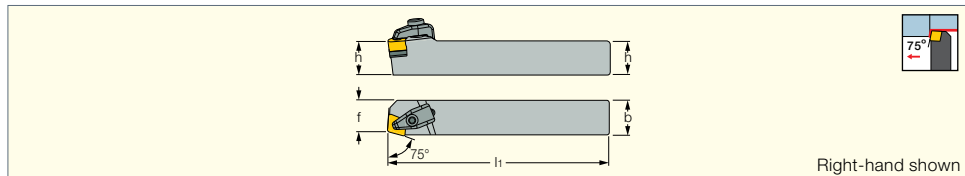

Right-hand shown

Designation	h	h ₁	b	l ₁	f	Insert						
TCBNR/L 2525M-12CH	25.0	25.0	25.0	150.00	22.00	CNGX 1207...T	S 48	SR M5X0.8X10	CCL 4	KSP 5	CSC 4	HW 4.0

ISOTURN

TCKNR/L-CH

75° Lead Angle Tools Carrying the 100° Corner of CNGX 80° Negative Rhombic Ceramic Dimpled Inserts for Facing

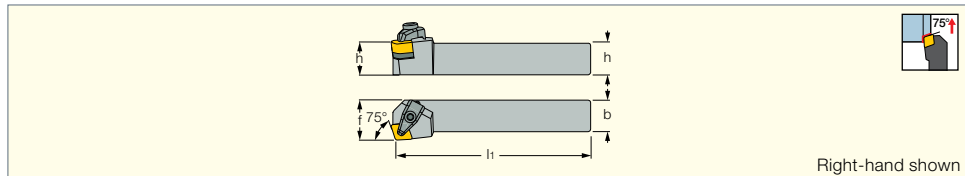

Right-hand shown

Designation	h	h ₁	b	l ₁	f	Insert						
TCKNR/L 2525M-12CH	25.0	25.0	25.0	150.00	32.00	CNGX 1207...T	S 48	SR M5X0.8X10	CCL 4	KSP 5	CSC 4	HW 4.0

ISOTURN

CSRNR/L

75° Lead Angle Tools Carrying the Square Ceramic Inserts

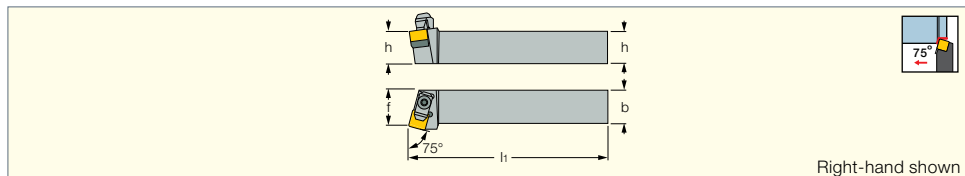

Right-hand shown

Designation	h	h ₁	b	l ₁	f	G _a °	G _r °	Insert
CSRNR/L 2525M-12CEA	25.0	25.0	25.0	150.00	27.00	-	-	SNGN 1204

Spare Parts

Designation					
CSRNR/L	S 40 (SEAT)	HW 4.0	BCL 6 CLAMP	SR M6X1X25ISO7380	SR M5X0.8X10

ISOTURN

TSRNR/L-CH

75° Lead Angle Tools Carrying the Square Ceramic Dimpled Inserts

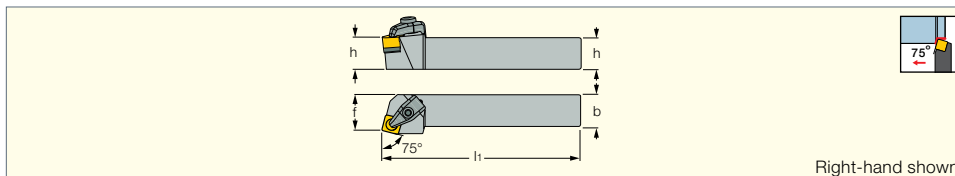

Right-hand shown

Designation	h	h ₁	b	l ₁	f	Insert						
TSRNR 2525M-12CH	25.0	25.0	25.0	150.00	27.00	SNGX 1207..T S 40	(SEAT)	SR M5X0.8X10	CCL 4	KSP 5	CSC 4	HW 4.0

ISOTURN

CSDNN-CE/CEA

45° Lead Angle Tools Carrying the Square Ceramic Inserts

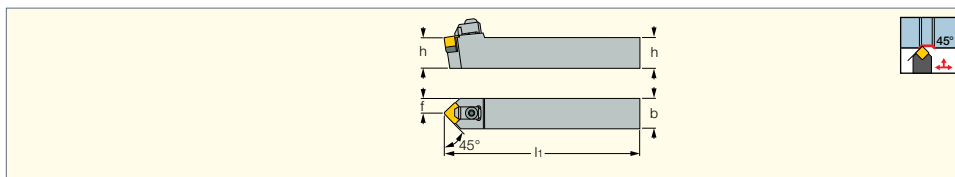

Designation	h	h ₁	b	l ₁	f	Insert
CSDNN 2525M-12CEA	25.0	25.0	25.0	150.00	12.50	SNGN 1204

Spare Parts

Designation						
CSDNN 2525M-12CEA	S 40 (SEAT)	SR M5X0.8X10	BCL 6 CLAMP	SR M6X1X25ISO7380	HW 4.0	HW 3.0

ISOTURN

TSDNN-CH

45° Lead Angle Tools Carrying the Square Ceramic Dimpled Inserts

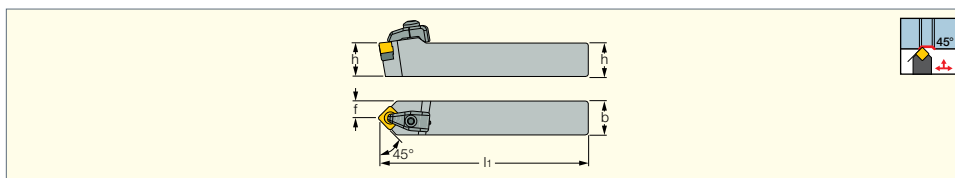

Designation	h	h ₁	b	l ₁	f						
TSDNN 2525M-12CH	25.0	25.0	25.0	150.00	12.50	S 40 (SEAT)	SR M5X0.8X10	CCL 4	KSP 5	CSC 4	HW 4.0

ISOTURN

CSSNR/L-CE

45° Lead Angle Tools Carrying the Square Ceramic Inserts for Longitudinal and Face Turning

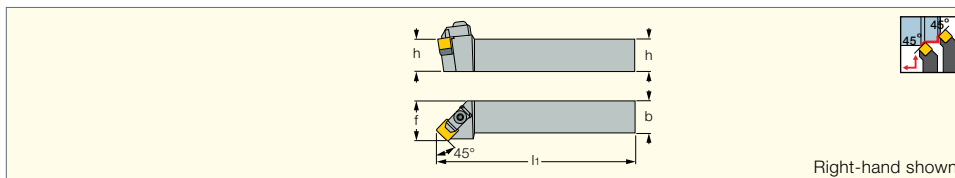

Right-hand shown

Designation	h	h ₁	b	l ₁	f	G _a °	G _r °	Insert
CSSNR/L 2525M-12CE	25.0	25.0	25.0	150.00	26.00	-	-	SNGN 1207

Spare Parts

Designation					
CSSNR/L-CE	S 40 (SEAT)	HW 4.0	BCL 6 CLAMP	SR M6X1X25ISO7380	SR M5X0.8X10

ISOTURN

TSSNR/L-CH

45° Lead Angle Tools Carrying the Square Ceramic Dimpled Inserts for Longitudinal and Face Turning

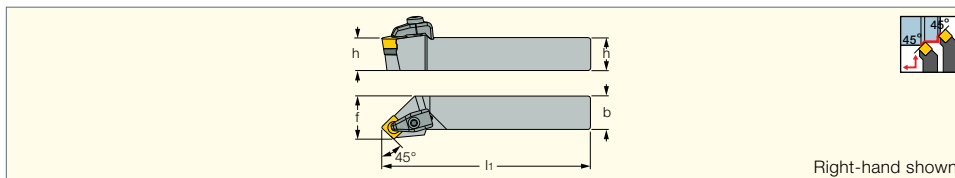

Right-hand shown

Designation	h	h ₁	b	l ₁	f	Insert						
TSSNR/L 2525M-12CH	25.0	25.0	25.0	150.00	32.00	SNGX 1207..T S 40	(SEAT)	SR M5X0.8X10	CCL 4	KSP 5	CSC 4	HW 4.0

ISOTURN

CTJNR/L

93° Lead Angle Tools Carrying the Triangular Ceramic Inserts for Longitudinal Turning

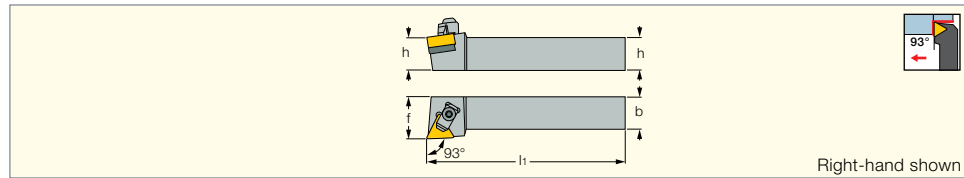

Right-hand shown

Designation	h	h ₁	b	l ₁	f	G _a °	G _r °	Insert
CTJNR 2525M-16CEA	25.0	25.0	25.0	150.00	32.00	-4	-4	TNGN 1604

Spare Parts

Designation					
CTJNR/L	S 3	HW 4.0	BCL 6 CLAMP	SR M6X1X25ISO7380	SR M4X8 ISO7380 SS

ISOTURN

TDJNR/L-CH

93° Lead Angle Tools Carrying the 55° Rhombic Dimpled Ceramic Inserts

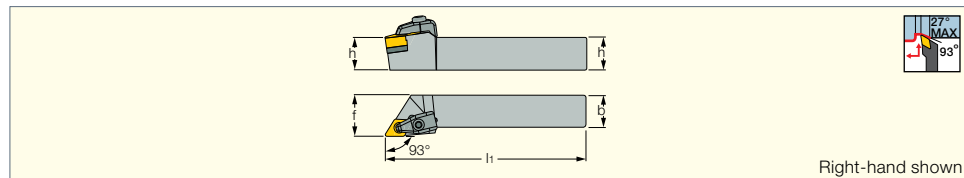

Right-hand shown

Designation	h	h ₁	b	l ₁	f	Insert					
TDJNR/L 2525M-15CH	25.0	25.0	25.0	150.00	32.00	DNGX 1507..T	SR M5X0.8X10	CCL 4	KSP 5	CSC 4	HW 4.0

ISOTURN

TDNNN-CH

62.5° Lead Angle Tools Carrying the 55° Rhombic Dimpled Ceramic Inserts

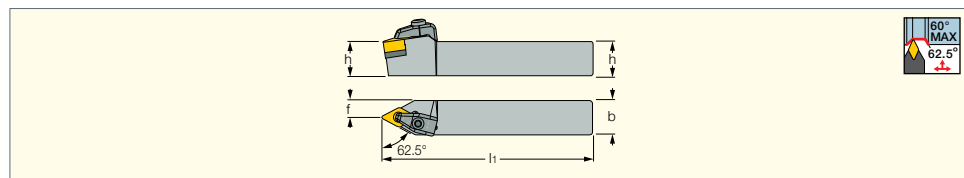

Designation	h	h ₁	b	l ₁	f	Insert					
TDNNN 2525M-15CH	25.0	25.0	25.0	150.00	12.50	DNGX 1507..T	SR M5X0.8X10	CCL 4	KSP 5	CSC 4	HW 4.0

ISOTURN

CRDNN

Clamp Lock Neutral Tools Carrying Ceramic Round Negative Inserts

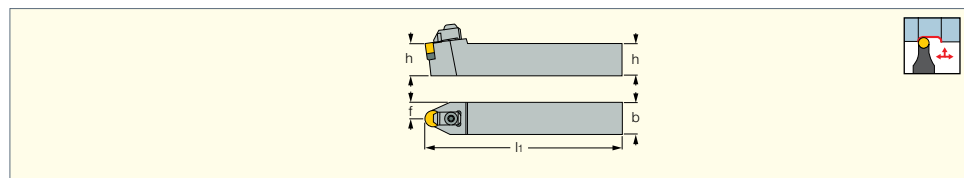

Designation	h	h ₁	b	l ₁	f	G _a °	G _r °	Insert					
CRDNN 2525M-12CE	25.0	25.0	25.0	150.00	12.50	-8.5	0	RNGN 120700	S 43	SR M5X0.8X10	BCL 6 CLAMP	SR M6X1X25ISO7380	HW 4.0
CRDNN 2525M-12CEA	25.0	25.0	25.0	150.00	12.50	-8.5	0	RNGN 120400	S 43	SR M5X0.8X10	BCL 6 CLAMP	SR M6X1X25ISO7380	HW 4.0
CRDNN 3225P-12CE	32.0	32.0	25.0	170.00	12.50	-8.5	0	RNGN 120700	S 43	SR M5X0.8X10	BCL 6 CLAMP	SR M6X1X25ISO7380	HW 4.0

ISOTURN

CRGNR/L

Clamp Lock Tools Carrying the Ceramic Round Negative Inserts

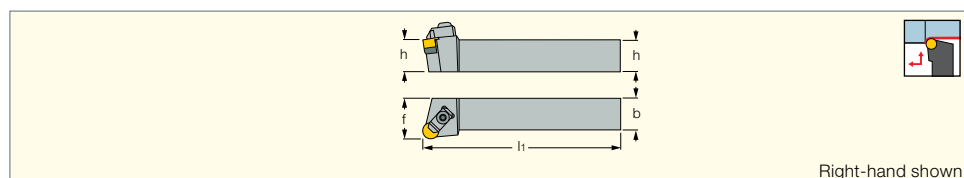

Right-hand shown

Designation	h	h ₁	b	l ₁	f	G _a °	G _r °	Insert					
CRGNR/L 2525M-12CE	25.0	25.0	25.0	150.00	32.00	-6	-6	RNGN 120700	S 43	SR M5X0.8X10	BCL 6 CLAMP	SR M6X1X25ISO7380	HW 4.0
CRGNR/L 2525M-12CEA	25.0	25.0	25.0	150.00	32.00	-6	-6	RNGN 120400	S 43	SR M5X0.8X10	BCL 6 CLAMP	SR M6X1X25ISO7380	HW 4.0
CRGNR/L 3225P-12CE	32.0	32.0	25.0	170.00	32.00	-6	-6	RNGN 120700	S 43	SR M5X0.8X10	BCL 6 CLAMP	SR M6X1X25ISO7380	HW 4.0

PCD



CBN



CER

